

Diagonal 4.595 mm (Type 1/4.0) 8 Mega-Pixel CMOS Image Sensor with Square Pixel for Color Cameras

IMX219PQH5-C

Description

The IMX219PQH5-C is a diagonal 4.595 mm (Type 1/4.0) CMOS active pixel type image sensor with a square pixel array and 8.08M effective pixels. This chip operates with three power supplies, analogue 2.8 V, digital 1.2 V, and IF 1.8 V, and has low power consumption. High sensitivity, low dark current, and no smear are achieved through the adoption of R, G, and B primary color pigment mosaic filters. This chip features an electronic shutter with variable charge-storage time.

In addition, this product is designed for use in cellular phone and tablet pc. When using this for another application, Sony does not guarantee the quality and reliability of product. Therefore, don't use this for applications other than cellular phone and tablet pc. Consult your Sony sales representative if you have any questions.

Features

- ◆ Back-illuminated CMOS image sensor Exmor R™
- ◆ 2-wire serial communication circuit on chip
- ◆ CSI2 serial data output (selection of 4lane/2lane)
- ◆ Timing generator, H and V driver circuits on chip
- ◆ CDS/PGA on chip
- ◆ 10-bit A/D converter on chip
- ◆ Automatic optical black (OB) clamp circuit on chip
- ◆ PLL on chip (rectangular wave)
- ◆ High sensitivity, low dark current, no smear
- ◆ Excellent anti-blooming characteristics
- ◆ Variable-speed shutter function (1 H units)
- ◆ R, G, B primary color pigment mosaic filters on chip
- ◆ Max. 30 frame/s in all-pixel scan mode
- ◆ Pixel rate: 280 [Mpixel/s] (All-pixels mode)
- ◆ 180 frame/s @720p with 2x2 analog (special) binning, 60 frame/s @1080p with V-crop
- ◆ Data rate: Max. 755 Mbps/lane(@4lane), 912Mbps/Lane(@2lane)

Exmor R

* Exmor R is a trademark of Sony Corporation. The Exmor R is a Sony's CMOS image sensor with significantly enhanced imaging characteristics including sensitivity and low noise by changing fundamental structure of Exmor™ pixel adopted column parallel A/D converter to back-illuminated type.

Sony reserves the right to change products and specifications without prior notice.

This information does not convey any license by any implication or otherwise under any patents or other right.

Application circuits shown, if any, are typical examples illustrating the operation of the devices. Sony cannot assume responsibility for any problems arising out of the use of these circuits.

Device Structure

◆ CMOS image sensor	
◆ Image size	: Diagonal 4.595 mm (Type 1/4.0)
◆ Total number of pixels	: 3296 (H) × 2512 (V) approx. 8.28 M pixels
◆ Number of effective pixels	: 3296 (H) × 2480 (V) approx. 8.17 M pixels
◆ Number of active pixels	: 3280 (H) × 2464 (V) approx. 8.08 M pixels
◆ Chip size	: 5.095 mm (H) × 4.930 mm (V) (w/ Scribe)
◆ Unit cell size	: 1.12 μm (H) × 1.12 μm (V)
◆ Substrate material	: Silicon

CONFIDENTIAL

USE RESTRICTION NOTICE

This USE RESTRICTION NOTICE ("Notice") is for customers who are considering or currently using the image sensor products ("Products") set forth in this specifications book. Sony Corporation ("Sony") may, at any time, modify this Notice which will be available to you in the latest specifications book for the Products. You should abide by the latest version of this Notice. If a Sony subsidiary or distributor has its own use restriction notice on the Products, such a use restriction notice will additionally apply between you and the subsidiary or distributor. You should consult a sales representative of the subsidiary or distributor of Sony on such a use restriction notice when you consider using the Products.

Use Restrictions

- The Products are intended for incorporation into such general electronic equipment as office products, communication products, measurement products, and home electronics products in accordance with the terms and conditions set forth in this specifications book and otherwise notified by Sony from time to time.
- You should not use the Products for critical applications which may pose a life- or injury- threatening risk or are highly likely to cause significant property damage in the event of failure of the Products. You should consult your sales representative beforehand when you consider using the Products for such critical applications. In addition, you should not use the Products in weapon or military equipment.
- Sony disclaims and does not assume any liability and damages arising out of misuse, improper use, modification, use of the Products for the above-mentioned critical applications, weapon and military equipment, or any deviation from the requirements set forth in this specifications book.

Design for Safety

- Sony is making continuous efforts to further improve the quality and reliability of the Products; however, failure of a certain percentage of the Products is inevitable. Therefore, you should take sufficient care to ensure the safe design of your products such as component redundancy, anti-conflagration features, and features to prevent mis-operation in order to avoid accidents resulting in injury or death, fire or other social damage as a result of such failure.

Export Control

- If the Products are controlled items under the export control laws or regulations of various countries, approval may be required for the export of the Products under the said laws or regulations. You should be responsible for compliance with the said laws or regulations.

No License Implied

- The technical information shown in this specifications book is for your reference purposes only. The availability of this specifications book shall not be construed as giving any indication that Sony and its licensors will license any intellectual property rights in such information by any implication or otherwise. Sony will not assume responsibility for any problems in connection with your use of such information or for any infringement of third-party rights due to the same. It is therefore your sole legal and financial responsibility to resolve any such problems and infringement.

Governing Law

- This Notice shall be governed by and construed in accordance with the laws of Japan, without reference to principles of conflict of laws or choice of laws. All controversies and disputes arising out of or relating to this Notice shall be submitted to the exclusive jurisdiction of the Tokyo District Court in Japan as the court of first instance.

Other Applicable Terms and Conditions

- The terms and conditions in the Sony additional specifications, which will be made available to you when you order the Products, shall also be applicable to your use of the Products as well as to this specifications book. You should review those terms and conditions when you consider purchasing and/or using the Products.

Contents

Description.....	1
Features	1
Device Structure	2
USE RESTRICTION NOTICE	3
1. Block Diagram and Pin Configuration.....	10
1-1 Block Diagram.....	10
1-2 Pin Description.....	10
1-3 Pin Equivalent Circuit	13
1-4 Chip Center, Optical Center and Pin Assignment	14
1-5 Pin Coordinates.....	15
2. Pixel Signal Output Specifications.....	16
2-1 CSI-2 Signalling Mode.....	16
2-1-1 MIPI Transmitter.....	16
2-1-2 Output Lane.....	16
3. Control Registers.....	17
3-1 2-wire Serial Communication Operation Specifications.....	17
3-1-1 Communication Protocol	17
3-1-2 2-wire serial communication read/write operation.....	19
3-1-3 2-wire serial communication block characteristics.....	23
3-1-4 2-wire serial communication register map.....	24
3-1-5 Register Synchronization (Frame Bank)	25
3-2 2-wire Serial Communication Register Map (Configuration register, Parameter limit register)	26
3-2-1 Configuration Registers – [0x0000-0x0FFF]	26
3-2-2 Set-up Registers – [0x0100-0x0147]	28
3-2-3 Frame Bank Control and Group “A” – [0x0150-0x018D].....	30
3-2-4 Frame Bank Control Group “B” – [0x0254-0x028D]	32
3-2-5 Set-up Registers – [0x0300-0x0627]	33
3-3 Parameter Limit Registers – [0x1000-0x1FFF] (Read Only and Static).....	36
3-3-1 Integration Time and Gain Parameter Limit Registers – [0x1000-0x1301]	36
3-4 Manufacturer Specific Registers – [0x3000-0x5FFF].....	41
3-5 Frame Bank A and Bank B specific output samples	43
4. Output Data Format.....	47
4-1 CSI-2 Output Data Format.....	47
4-1-1 CSI-2 Output Data Channels.....	47
4-1-2 CSI-2 Frame Structure	47
4-1-3 Short Packet & Long Packet.....	48
4-1-4 Data type	49

4-1-5	CSI-2 Frame Format	49
4-1-6	CSI-2 Embedded Data Line.....	50
5-1	Pixel Array Physical Image	52
5-2	Pixel Binning Mode	53
5-3	image size.....	54
5-4	Readout Position.....	55
5-5	Frame Rate Calculation Formula.....	56
5-6	Black Level Control	56
5-7	Storage Time (Electronic Shutter) Settings	56
5-7-1	Storage Time (Electronic Shutter) Setting Registers.....	56
5-7-2	Storage Time Calculation Method.....	57
5-8	Gain Settings	58
5-8-1	Analogue Gain Settings.....	58
5-8-2	Digital gain settings.....	60
6.	On Chip Image Processing	62
6-1	Test Pattern Generator	62
6-1-1	Test Pattern	62
6-2	Digital Gain Setting.....	67
6-3	Black Level Adjust	67
6-4	Defect Correction	67
6-5	Pixel Re-alignment H Direction.....	67
6-6	Pixel Re-alignment V Direction	68
7.	NVM Memory Map.....	69
7-1	Block Diagram.....	69
7-2	NVM Functions	69
7-3	Related Registers.....	70
7-4	NVM Memory Map	72
7-5	Defects Address registration.....	75
7-5-1	Single defect address.....	75
7-5-2	Same Color Adjoining defect address	75
7-5-3	2x4 defect address.....	75
7-5-4	Example Setting.....	76
8.	How to operate IMX219PQH5-C.....	77
8-1	Power on sequence	77
8-2	Power off sequence	79
9.	Other Functions.....	81
9-1	Clock System	81
9-1-1	Clock Structure	81
9-1-2	EXCK_FREQ setting depend on INCK frequency	81

9-2 Clock Setting Example 82

9-3 Temperature Sensor 83

10. Electrical Characteristics 84

 10-1 Absolute Maximum Ratings 84

 10-2 Recommended Operating Conditions 84

 10-3 Electrical Characteristics 85

 10-4 AC Characteristics 86

 10-4-1 Master Clock Waveform Diagram 86

 10-5 Electrical Characteristics 86

11. Spectral Sensitivity Characteristic 87

12. Image Sensor Characteristics 88

 12-1 Image Sensor Characteristics 88

 12-2 Zone Definition used for specifying image sensor characteristics 88

13. Measurement Method for Image Sensor Characteristics 89

 13-1 Measurement conditions 89

 13-2 Color Coding of This Image Sensor and Readout 89

 13-3 Definition of Standard Imaging Conditions 89

 13-4 Measurement method 90

14. Spot Pixel Specification 91

15. Notice on White Pixels Specifications 92

 15-1 Measurement Method for Spot Pixels 93

 15-2 Spot Pixel Pattern Specifications 93

16. Chief Ray Angle Characteristics 94

17. Connection Example 95

18. Notes On Handling 96

CONFIDENTIAL

Table of Figures

Fig. 1 Block Diagram	10
Fig. 2 Pin Equivalent Circuit	13
Fig. 3 Chip Center and Optical Center.....	14
Fig. 4 Relationship between Output pin name and MIPI output Lane	16
Fig. 5 2-wire Serial Communication.....	17
Fig. 6 2-wire Serial Communication Protocol.....	17
Fig. 7 Start Condition	18
Fig. 8 Repeated Start Condition	18
Fig. 9 Stop Condition	18
Fig. 10 Slave Address.....	18
Fig. 11 Acknowledge and Negative Acknowledge	19
Fig. 12 CCI single read from random location.....	20
Fig. 13 CCI single read from current location.....	20
Fig. 14 CCI sequential read starting from random location	21
Fig. 15 CCI sequential read starting from current location	21
Fig. 16 CCI single write to random location	22
Fig. 17 CCI sequential write starting from random location.....	22
Fig. 18 2-wire Serial Communication Specifications.....	23
Fig. 19 Function Example for Frame Bank	25
Fig. 20 Frame Structure for Serial signal output	47
Fig. 21 Signaling Waveform during Line Blanking Period (CSI-2).....	48
Fig. 22 Signaling Waveform during Frame Blanking Period (CSI-2)	48
Fig. 23 Short Packet & Long Packet.....	48
Fig. 24 Frame Format during Embedded Data Line Output	50
Fig. 25 Embedded data lines alignment in RAW8 mode	50
Fig. 26 Detailed Embedded Data Line Output in RAW10 Output Mode.....	50
Fig. 27 Pixel Array Physical Image.....	52
Fig. 28 Image of 2x2 averaged Binning Mode	53
Fig. 29 Image size	54
Fig. 30 Readout Position.....	55
Fig. 31 Output Image Diagrams for Vertical Flip and Horizontal Mirror.....	55
Fig. 32 Data Flow Diagram	62
Fig. 33 Block Diagram	69
Fig. 34 NVM Map structure	69
Fig. 35 Single defect.....	75
Fig. 36 Same Color Adjoining defect	75
Fig. 37 2x4 defect	75
Fig. 38 Power-on Sequence in 2-wire Serial Communication Mode.....	77

Fig. 39 Start streaming sequence with 2-wire serial communication (external reset)	78
Fig. 40 Power-off Sequence in 2-wire Serial Communication.....	79
Fig. 41 Software Standby Operation Pattern 1	80
Fig. 42 Software Standby Operation Pattern 2	80
Fig. 43 Clock System Block Diagram	81
Fig. 44 Master Clock Square Waveform Diagram.....	86
Fig. 45 Spectral sensitivity characteristics	87
Fig. 46 Zone Definition Diagram.....	88
Fig. 47 Color coding alignment.....	89
Fig. 48 Measurement Method for Spot Pixels.....	93
Fig. 49 Chief Ray Angle Characteristics.....	94
Fig. 50 Recommended Circuit.....	95

Tables

Table 1 Pin Description	10
Table 2 Pin Coordinates.....	15
Table 3 Description of 2-wire Serial Communication Pins	17
Table 4 R/W Bit.....	18
Table 5 2-wire Serial Communication Address Space.....	19
Table 6 Operations Supported by 2-wire Serial Communication	19
Table 7 2-wire Serial Communication Operation Specifications	23
Table 8 2-wire Serial Communication AC Timing (Fast mode plus (INCK[fSCK] = 11.4 to 27 MHz))	23
Table 9 2-wire Serial Communication AC Timing (Fast mode).....	24
Table 10 2-wire Serial Communication Register Map Address Areas	24
Table 11 Access command sequence.....	41
Table 12 Number of CSI lane Setting Registers.....	47
Table 13 Image pixel area and data type.....	49
Table 14 Sync Code Settings	49
Table 15 Embedded Data Line Tag	51
Table 16 Mode example.....	53
Table 17 Image Orientation Register	55
Table 18 Gain Setting Variables	56
Table 19 Storage Time Setting Register.....	56
Table 20 Storage Time Offset Register.....	56
Table 21 Storage Time Setting (in case of Line_Length_pck = 3448).....	57
Table 22 Gain Setting Variables	58
Table 23 Analogue Gain Setting	59
Table 24 Digital Gain Settings	60
Table 25 Example of Digital Gain Setting	61

Table 26 Description of Test Pattern Registers.....	63
Table 27 Description of Test Patterns.....	64
Table 28 Black Level Adjust Setting Register.....	67
Table 29 Pixel Re-alignment H Direction Setting Registers.....	67
Table 30 Pixel Re-alignment V Direction Setting Registers.....	68
Table 31 Functions via NVM.....	69
Table 32 Related Registers.....	70
Table 33 NVM Memory capacity.....	72
Table 34 NVM Memory Map Example.....	72
Table 35 Example setting of defect pixel.....	76
Table 36 Operation Specifications 2-wire Serial Communication Mode.....	78
Table 37 Initialization sequence with XCLR.....	78
Table 38 Operation Specifications in 2-wire Serial Communication.....	79
Table 39 EXCK_FREQ setting table.....	81
Table 40 Temperature setting registers.....	83
Table 41 Absolute Maximum Ratings.....	84
Table 42 Recommended Operating Conditions.....	84
Table 43 DC Characteristics.....	85
Table 44 Master Clock Square Waveform Input Characteristics.....	86
Table 45 Electrical Characteristics.....	86
Table 46 Image Sensor Characteristics.....	88
Table 47 Measurement Conditions.....	89
Table 48 Spot Pixel Specifications.....	91

1. Block Diagram and Pin Configuration

1-1 Block Diagram

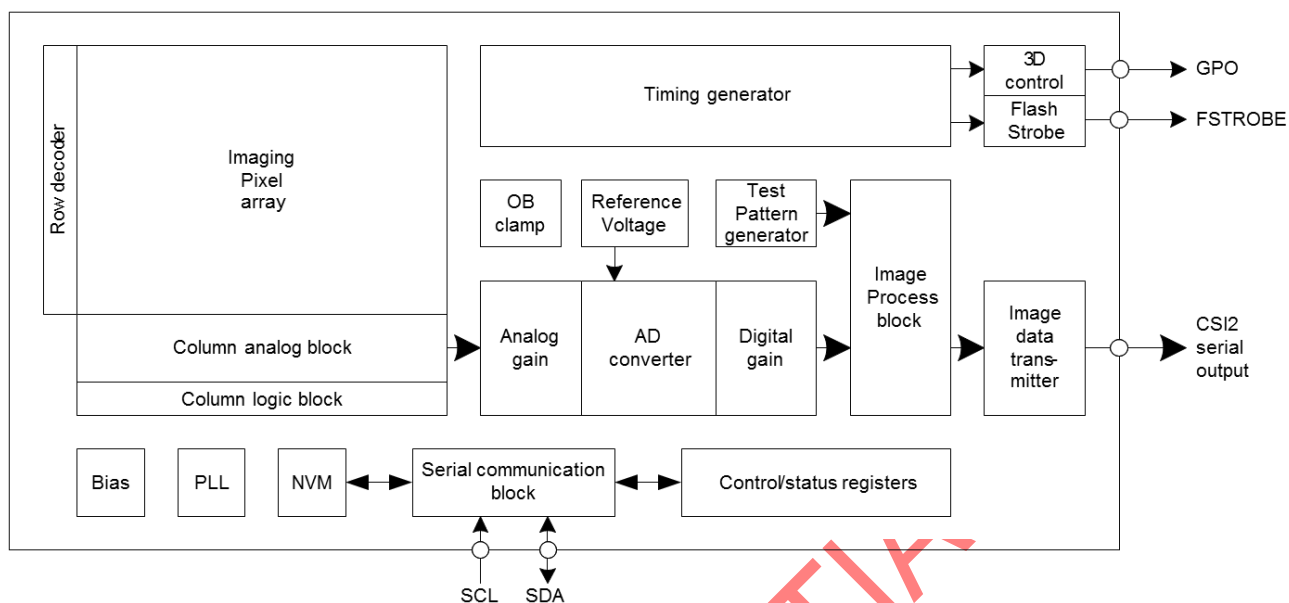

Fig. 1 Block Diagram

1-2 Pin Description

Table 1 Pin Description

Pin No.	Symbol	I/O	A/D	Description	Remarks
1	VDDLSC1	Power	D	1.2 V Power	
2	VSSLSC1	GND	D	1.2 V GND	
3	VDDHCM1	Power	A	2.8 V Power	
4	VSSHCM1	GND	A	2.8 V GND	
5	VSSLCN1	GND	D	1.2 V GND	
6	VDDLSC1	Power	D	1.2 V Power	
7	VSSLDM1			Dummy	NC
8	VSSLSC2	GND	D	1.2 V GND	
9	VDDHFIL1	Power	A	2.8 V Power	= V _{ANA}
10	VDDLSC2	Power	D	1.2 V Power	
11	VSSLCN2	GND	D	1.2 V GND	
12	VSSHCM2	GND	A	2.8 V GND	
13	VDDHCM2	Power	A	2.8 V Power	
14	VSSLSC3	GND	D	1.2 V GND	
15	VDDLSC3	Power	D	1.2 V Power	
16	VCP	O	A	Analog Output	Connect to capacitor (2.2 μF)
17	VBO	O	A	Analog Output	Connect to capacitor (1.0 μF)
18	VSSHSN1	GND	A	2.8 V GND	

Pin No.	Symbol	I/O	A/D	Description	Remarks
19	VDDHSN1	Power	A	2.8 V Power	
20	VSSLSC4	GND	D	1.2 V GND	
21	POREN	I	D	Digital Input	Connect to VDIG
22	XCLR	I	D	Digital Input	
23	TENABLE	I	D	Digital Input	NC
24	GPO	I/O	D	Digital Input / Output	Connect to VSSLSC when GPO is not enable
25	FSTROBE	O	D	Digital Output	
26	SDA	I/O	D	Digital Input / Output	
27	SCL	I	D	Digital Input	
28	TEST1	I	D	Digital Input	NC
29	SWTCK	I	D	Digital Input	NC
30	INCK	I	D	Digital Input	
31	VDDMCO	Power	D	1.8 V Power	
32	VSSLSC5	GND	D	1.2 V GND	
33	VDDLSC5	Power	D	1.2 V Power	
34	VDDHFIL2	Power	A	2.8 V Power	= V _{ANA}
35	VDDLSC6	Power	D	1.2 V Power	
36	VSSLSC6	GND	D	1.2 V GND	
37	VSSLDM2			Dummy	NC
38	VDDLSC7	Power	D	1.2 V Power	
39	VSSLSC7	GND	D	1.2 V GND	
40	VDDLIO1	Power	D	1.2 V Power	
41	VSSLIO1	GND	D	1.2 V GND	
42	DMO1N	O	D	Digital Output	
43	DMO1P	O	D	Digital Output	
44	DMO2N	O	D	Digital Output	
45	DMO2P	O	D	Digital Output	
46	VSSLIO2	GND	D	1.2 V GND	
47	DCKN	O	D	Digital Output	
48	DCKP	O	D	Digital Output	
49	VSSLIO3	GND	D	1.2 V GND	
50	DMO3N	O	D	Digital Output	
51	DMO3P	O	D	Digital Output	
52	DMO4N	O	D	Digital Output	
53	DMO4P	O	D	Digital Output	
54	VSSLIO4	GND	D	1.2 V GND	
55	VDDLIO2	Power	D	1.2 V Power	
56	VSSLSC8	GND	D	1.2 V GND	
57	VDDLSC8	Power	D	1.2 V Power	

Pin No.	Symbol	I/O	A/D	Description	Remarks
58	VSSHPL	GND	A	2.8 V GND	
59	VDDHPL	Power	A	2.8 V Power	
60	TVCD SIN	I	A	Analog Input	NC, For test
61	TVMON	O	A	Analog Output	NC, For test
62	VSSHAN	GND	A	2.8 V GND	
63	VDDHAN	Power	A	2.8 V Power	
64	VDDHSN2	Power	A	2.8 V Power	
65	VSSH SN2	GND	A	2.8 V GND	

CONFIDENTIAL

1-3 Pin Equivalent Circuit

Symbol	Equivalent circuit	Symbol	Equivalent circuit
VCP		VBO	
XCLR		INCK	
SDA SCL		GPO	
FSTROBE		POREN	

VDDH: 2.8 V power supply, VDIG: 1.8 V power supply, VDDL: 1.2 V power supply
 VSSH: 2.8 V GND, VSSL: 1.2 V GND

Fig. 2 Pin Equivalent Circuit

1-4 Chip Center, Optical Center and Pin Assignment

(Unit: μm)

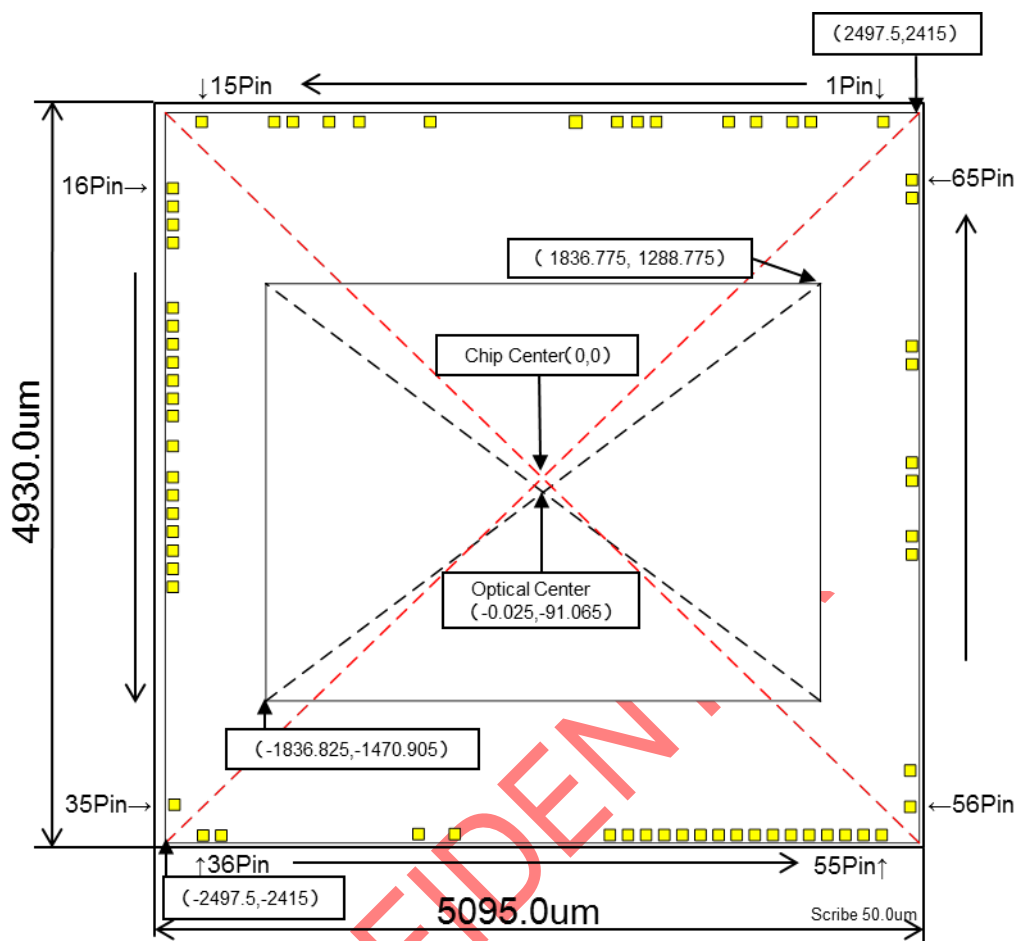

Fig. 3 Chip Center and Optical Center

1-5 Pin Coordinates

Table 2 Pin Coordinates

Pin No.	Symbol	X (pad center)	Y (pad center)	Pin No.	Symbol	X (pad center)	Y (pad center)
1	VDDLSC1	2247.50	2355.00	35	VDDLSC6	-2447.50	-2165.00
2	VSSLSC1	1767.50	2355.00	36	VSSLSC6	-2247.50	-2365.00
3	VDDHCM1	1647.50	2355.00	37	VSSLDM2	-2127.50	-2365.00
4	VSSHCM1	1407.50	2355.00	38	VDDLSC7	-807.50	-2365.00
5	VSSLCN1	1167.50	2355.00	39	VSSLSC7	-567.50	-2365.00
6	VDDL CN1	687.50	2355.00	40	VDDLIO1	447.50	-2365.00
7	VSSLDM1	567.50	2355.00	41	VSSLIO1	567.50	-2365.00
8	VSSLSC2	447.50	2355.00	42	DMO1N	687.50	-2365.00
9	VDDHFIL1	167.50	2356.00	43	DMO1P	807.50	-2365.00
10	VDDL CN2	-727.50	2355.00	44	DMO2N	927.50	-2365.00
11	VSSLCN2	-1207.50	2355.00	45	DMO2P	1047.50	-2365.00
12	VSSHCM2	-1407.50	2355.00	46	VSSLIO2	1167.50	-2365.00
13	VDDHCM2	-1647.50	2355.00	47	DCKN	1287.50	-2365.00
14	VSSLSC3	-1767.50	2355.00	48	DCKP	1407.50	-2365.00
15	VDDLSC3	-2247.50	2355.00	49	VSSLIO3	1527.50	-2365.00
16	VCP	-2447.50	1915.00	50	DMO3N	1647.50	-2365.00
17	VBO	-2447.50	1795.00	51	DMO3P	1767.50	-2365.00
18	VSSH SN1	-2447.50	1675.00	52	DMO4N	1887.50	-2365.00
19	VDDHSN1	-2447.50	1555.00	53	DMO4P	2007.50	-2365.00
20	VSSLSC4	-2447.50	1125.00	54	VSSLIO4	2127.50	-2365.00
21	POREN	-2447.50	1005.00	55	VDDLIO2	2247.50	-2365.00
22	XCLR	-2447.50	885.00	56	VSSLSC8	2447.50	-2165.00
23	TENABLE	-2447.50	765.00	57	VDDLSC8	2447.50	-1925.00
24	GPO	-2447.50	645.00	58	VSSHPL	2447.50	-507.00
25	FSTROBE	-2447.50	525.00	59	VDDHPL	2447.50	-387.00
26	SDA	-2447.50	405.00	60	TVCD SIN	2447.50	-20.00
27	SCL	-2447.50	205.00	61	TVMON	2447.50	100.00
28	TEST1	-2447.50	5.00	62	VSSHAN	2447.50	750.00
29	SWTCK	-2447.50	-115.00	63	VDDHAN	2447.50	870.00
30	INCK	-2447.50	-235.00	64	VDDHSN2	2447.50	1850.00
31	VDDMCO	-2447.50	-355.00	65	VSSH SN2	2447.50	1970.00
32	VSSLSC5	-2447.50	-480.00				
33	VDDLSC5	-2447.50	-600.00				
34	VDDHFIL2	-2447.50	-726.00				

2. Pixel Signal Output Specifications

IMX219PQH5-C has CSI-2 interface and the options are 4 lanes or 2lanes.

2-1 CSI-2 Signalling Mode

2-1-1 MIPI Transmitter

Output pin of CSI-2 are shown below

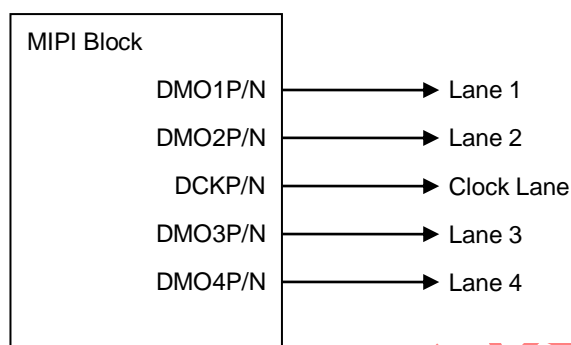

Fig. 4 Relationship between Output pin name and MIPI output Lane

Data and clock signals are transmitted using CSI-2 interface (high speed serial interface). Detailed explanation of CSI-2 interface is in following two documents, "MIPI Alliance Standard for Camera Serial Interface2 (CSI-2) Version 1.01" and "MIPI Alliance Specification for D-PHY Version 1.10.00". In CSI-2 interface, one bit of data is transmitted by a pair of differential signals. In the transmitter of CSI-2 interface, differential digital signals of data or clock are converted to differential current signals. At the receiver of CSI-2 interface, inserting output resistance, which is serial to a pair of differential outputs (data or clock), or connecting the receiver block, which includes internal resistance for a pair of differential outputs (data or clock), is required. In the case of using output resistance, output resistance is placed close to the receiver. Additionally, it is recommended that each space between differential output lines such as DMO1P/DMO1N, DMO2P/DMO2N, DMO3P/DMO3N, DMO4P/DMO4N, or DCKP/DCKN is identical, the length of all differential output lines is same, and output line length between the transmitter and the receiver is minimum.

2-1-2 Output Lane

Two or Four data output Lanes are applied from MIPI Alliance Standard for Camera Serial Interface2 (CSI-2) Version 1.01.

2-1-2-1 2Lane Output

Outputs of data and clock come from CSI-2 output pins (DMO1P/DMO1N, DMO2P/DMO2N, DCKP/DCKN). A pair of DMO1P/DMO1N is called Lane1 data and a pair of DMO2P/DMO2N is called Lane2 data. Also, clock signals come from CSI-2 output pins, DCKP/DCKN. Maximum output data rate is 912 Mbps/lane. (1lane output is not supported).

3. Control Registers

The IMX219PQH5-C can use the 2-wire serial communication method for sensor control. These specifications are described for sensor control using the 2-wire serial communication as follows.

3-1 2-wire Serial Communication Operation Specifications

The 2-wire serial communication method conforms to the Camera Control Instance (CCI). CCI is an I2C fast-mode plus (INCK[fSCK] = 11.4 to 27 MHz) compatible interface, and the data transfer protocol is I2C standard. This 2-wire serial communication circuit can be used to access the control-registers and status-registers of IMX219PQH5-C.

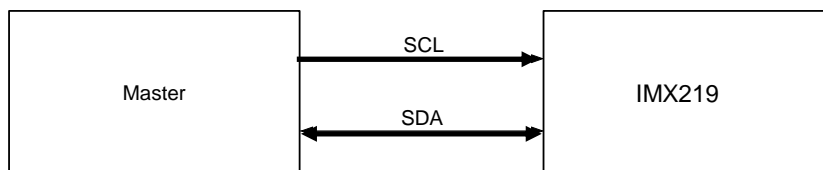

Fig. 5 2-wire Serial Communication

Table 3 Description of 2-wire Serial Communication Pins

Symbol	Description
SDA	Serial data communication
SCL	Serial clock input

3-1-1 Communication Protocol

2-wire serial communication supports a 16-bit register address and 8-bit data message type.

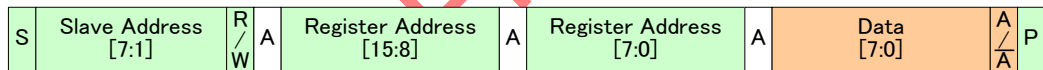

- From Master to Slave
- Direction Dependent on Operation
- From Slave to Master
- S=Start Condition
- (Sr=Repeated Start Condition)
- A=Acknowledge
- \bar{A} =Negative Acknowledge
- P=Stop Condition

Fig. 6 2-wire Serial Communication Protocol

Data is transferred serially, MSB first in 8-bit units. After each data byte is transferred, A (Acknowledge)/ \bar{A} (Acknowledge) is transferred. Data (SDA) is transferred at the clock (SCL) cycle. SDA can change only while SCL is Low, so the SDA value must be held while SCL is High.

The Start condition is defined by SDA changing from High to Low while SCL is High. When the Stop condition is not generated in the previous communication phase and Start condition for the next communication is generated, that Start condition is recognized as a Repeated Start condition.

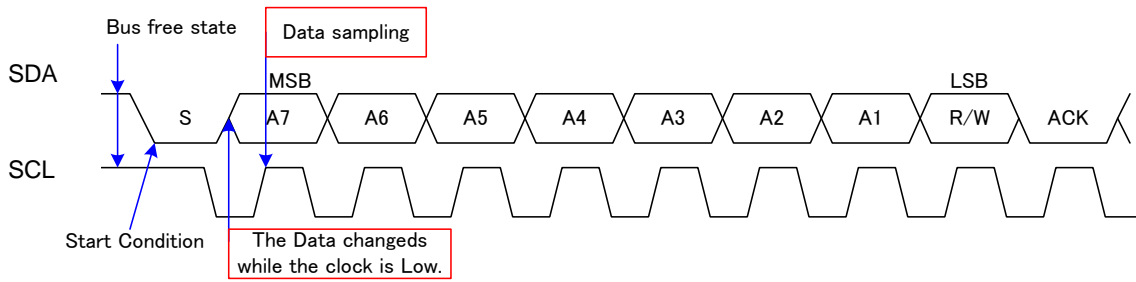

Fig. 7 Start Condition

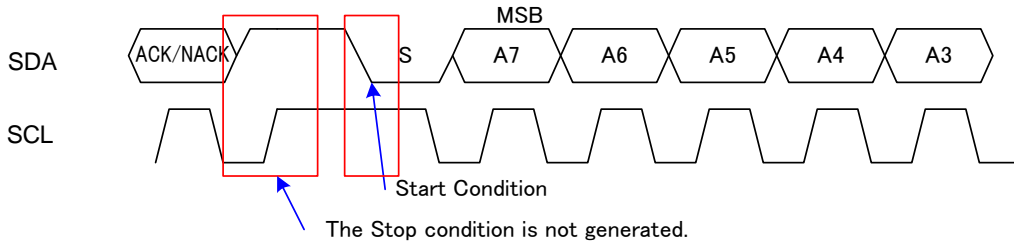

Fig. 8 Repeated Start Condition

The Stop condition is defined by SDA changing from Low to High while SCL is High.

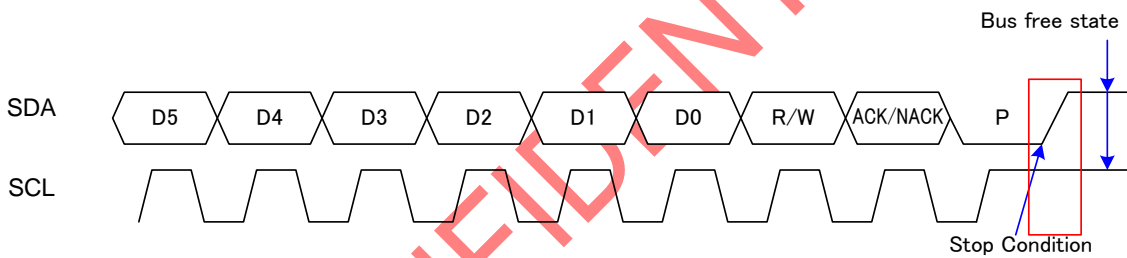

Fig. 9 Stop Condition

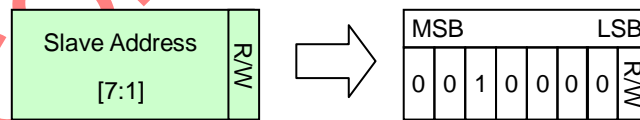

Fig. 10 Slave Address

The R/W bit indicates the data transfer direction.

Table 4 R/W Bit

R/W bit	Transfer direction
0	Write (Master → Sensor)
1	Read (Sensor → Master)

After transfer of each data byte, the Master or the sensor transmits an Acknowledge / Negative Acknowledge and releases (does not drive) SDA. When Negative Acknowledge is generated, the Master must immediately generate the Stop condition and end the communication.

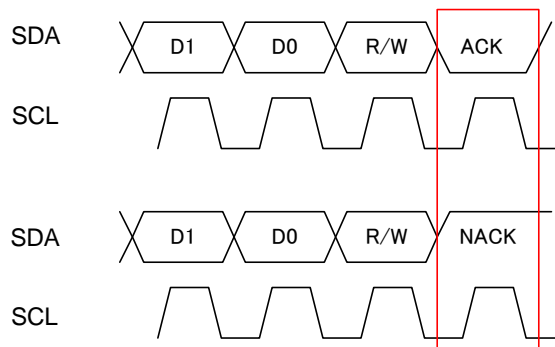

Fig. 11 Acknowledge and Negative Acknowledge

The registers have a 16-bit address space, and are assigned as follows.

Table 5 2-wire Serial Communication Address Space

Address area	Description
0x0000 - 0x0FFF	Configuration register
0x1000 - 0x1FFF	Parameter limit register Read Only and Static register
0x3000 - 0xFFFF	Manufacture specific register

3-1-2 2-wire serial communication read/write operation supported

The IMX219PQH5-C supports the following four read operations and two write operations that conform to the SMIA standard.

Table 6 Operations Supported by 2-wire Serial Communication

1	CCI Single read from random location (Single read from an optional address)
2	CCI Single read from current location (Single read from the held address)
3	CCI sequential read starting from random location (Sequential read starting from an optional address)
4	CCI sequential read starting from current location (Sequential read starting from the held address)
5	CCI single write to random location (Single write to an optional address)
6	CCI sequential write starting from random location (Sequential write starting from an optional address)

3-1-2-1 CCI single read from random location

The sensor has an index function that indicates which address it is focusing on. In reading the data at an optional single address, the Master must set the index value to the address to be read. For this purpose it performs dummy write operation up to the register address. The upper level of the figure below shows the sensor internal index value, and the lower level of the figure shows the SDA I/O data flow. The Master sets the sensor index value to M by designating the sensor slave address with a write request, then designating the address (M). Then, the Master generates the start condition. The Start condition is generated without generating the Stop condition, so it becomes the Repeated Start condition. Next, when the Master sends the slave address with a read request, the sensor outputs an Acknowledge immediately followed by the index address data on SDA. After the Master receives the data, it generates a Negative Acknowledge and the Stop condition to end the communication.

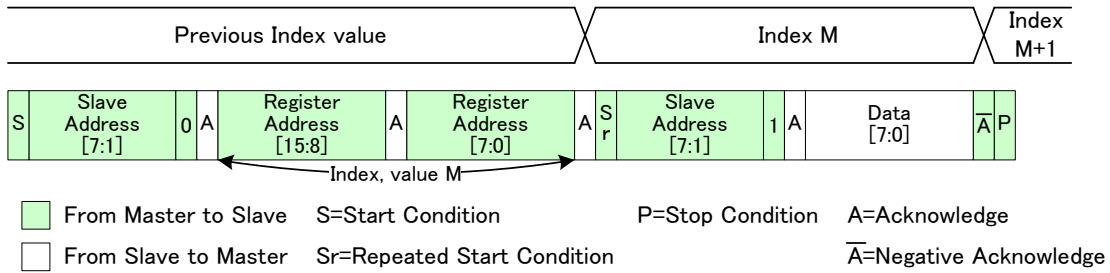

Fig. 12 CCI single read from random location

3-1-2-2 CCI single read from current location

After the slave address is transmitted by a write request, that address is designated by the next communication and the index holds that value. In addition, when data read/write is performed, the index is incremented by the subsequent Acknowledge/Negative Acknowledge timing. When the index value is known to indicate the address to be read, sending the slave address with a read request allows the data to be read immediately after Acknowledge. After receiving the data, the Master generates a Negative Acknowledge and the Stop condition to end the communication, but the index value is incremented, so the data at the next address can be read by sending the slave address with a read request.

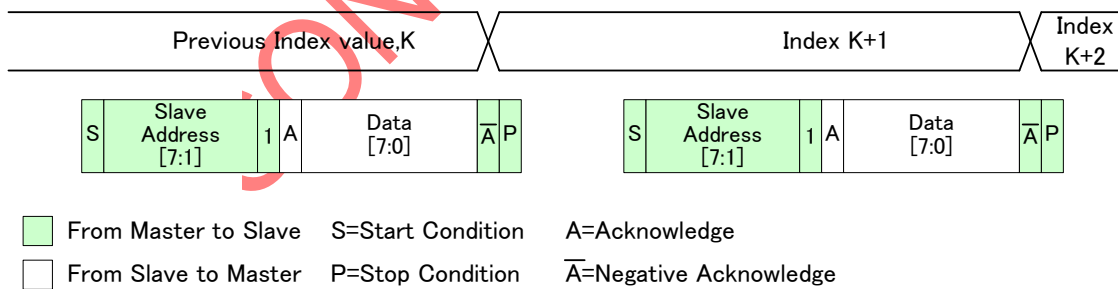

Fig. 13 CCI single read from current location

3-1-2-3 CCI sequential read starting from random location

In reading data sequentially, which is starting from an optional address, the Master must set the index value to the start of the addresses to be read. For this purpose, dummy write operation includes the register address setting. The Master sets the sensor index value to M by designating the sensor slave address with a read request, then designating the address (M). Then, the Master generates the Repeated Start condition. Next, when the Master sends the slave address with a read request, the sensor outputs an Acknowledge followed immediately by the index address data on SDA. When the Master outputs an Acknowledge after it receives the data, the index value inside the sensor is incremented and the data at the next address is output on SDA. This allows the Master to read data sequentially. After reading the necessary data, the Master generates a Negative Acknowledge and the Stop condition to end the communication.

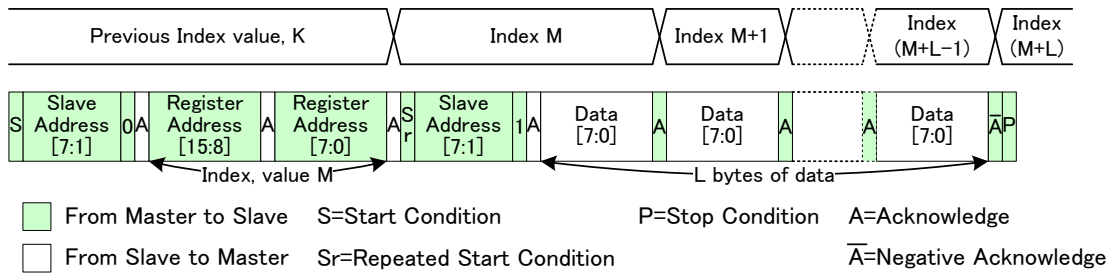

Fig. 14 CCI sequential read starting from random location

3-1-2-4 CCI sequential read starting from current location

When the index value is known to indicate the address to be read, sending the slave address with a read request allows the data to be read immediately after the Acknowledge. When the Master outputs an Acknowledge after it receives the data, the index value inside the sensor is incremented and the data at the next address is output on SDA. This allows the Master to read data sequentially. After reading the necessary data, the Master generates a Negative Acknowledge and the Stop condition to end the communication.

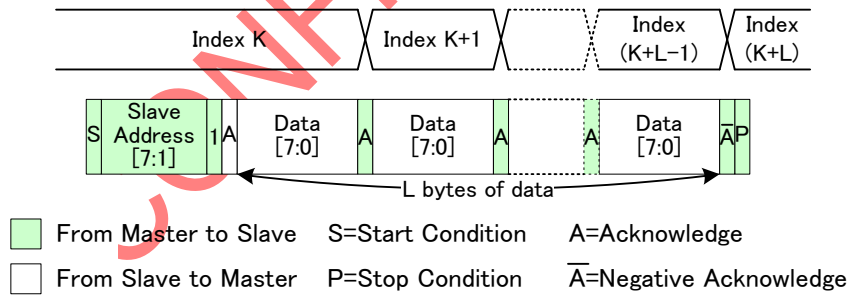

Fig. 15 CCI sequential read starting from current location

3-1-2-5 CCI single write to random location

The Master sets the sensor index value to M by designating the sensor slave address with a write request, and designating the address (M). After that the Master can write the value in the designated register by transmitting the data to be written. After writing the necessary data, the Master generates the Stop condition to end the communication.

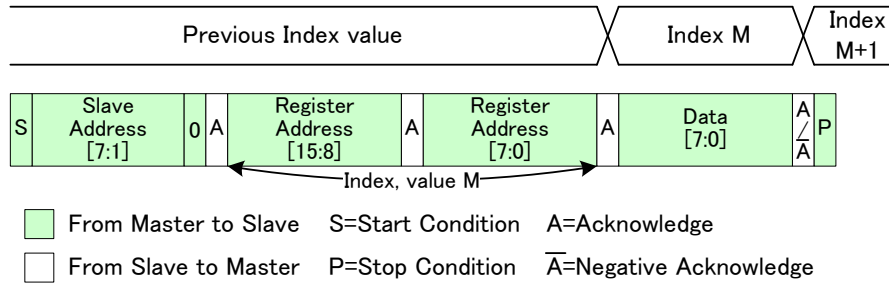

Fig. 16 CCI single write to random location

3-1-2-6 CCI sequential write starting from random location

The Master can write a value to register address M by designating the sensor slave address with a write request, designating the address (M), and then transmitting the data to be written. After the sensor receives the write data, it outputs an Acknowledge and at the same time increments the register address, so the Master can write to the next address simply by continuing to transmit data. After the Master writes the necessary number of bytes, it generates the Stop condition to end the communication.

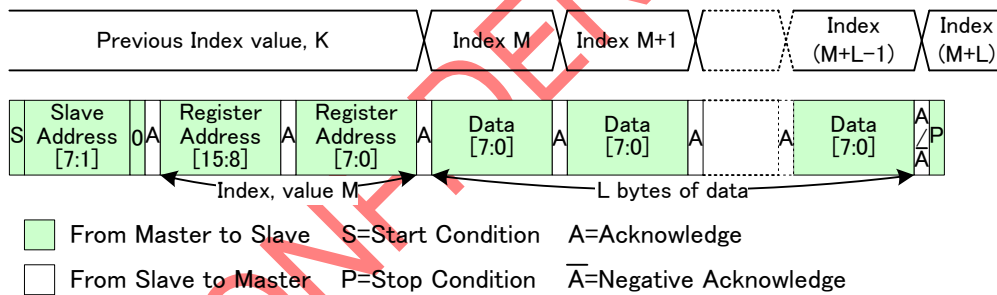

Fig. 17 CCI sequential write starting from random location

3-1-3 2-wire serial communication block characteristics

The block operation specifications for 2-wire serial communication are show below.

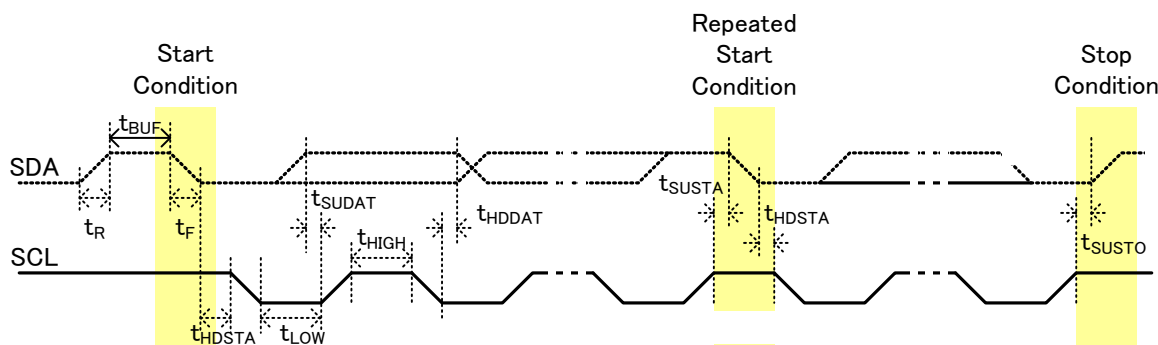

Fig. 18 2-wire Serial Communication Specifications

Table 7 2-wire Serial Communication Operation Specifications

Item	Symbol	Conditions	Min.	Max.	Unit
Low level input voltage	VIL		-0.5	0.3VDIG	V
High level input voltage	VIH		0.7VDIG	VDIG+0.5	V
Low level output voltage	VOL	VDIG < 2 V, Sink 2 mA		0.25VDIG	V
High level output voltage	VOH	VDIG < 2 V, Sink 2 mA	0.75VDIG		V
Output fall time	tof	Load 10 pF – 400 pF, 0.7VDIG – 0.3VDIG		120	ns
Input current	II	0.1VDIG -0.9VDIG	-10	10	μA
SDA I/O capacitance	CI/O			8	pF
SCL Input capacitance	CI			6	pF

Table 8 2-wire Serial Communication AC Timing (Fast mode plus (INCK[fSCK] = 11.4 to 27 MHz))

Item	Symbol	Min.	Max.	Unit
SCL clock frequency (INCK[fSCK] = 11.4 to 27 MHz)	f _{SCL}	0	1000	kHz
Rise time (SDA and SCL)	t _R	—	120	ns
Fall time (SDA and SCL)	t _F	—	120	ns
Hold time (start condition)	t _{HDSTA}	0.26	—	μs
Setup time (rep.-start condition)	t _{SUSTA}	0.26	—	μs
Setup time (stop condition)	t _{SUSTO}	0.26	—	μs
Data setup time	t _{SUDAT}	50	—	ns
Data hold time	t _{HDDAT}	0	—	μs
Bus free time between Stop and Start condition	t _{BUF}	0.5		μs
Low period of the SCL clock	t _{LOW}	0.5		μs
High period of the SCL clock	t _{HIGH}	0.26		μs

Table 9 2-wire Serial Communication AC Timing (Fast mode)

Item	Symbol	Min.	Max.	Unit
SCL clock frequency (INCK[fSCK] = 6 to 27 MHz)	f _{SCL}	0	400	kHz
Rise time (SDA and SCL)	t _R	—	300	ns
Fall time (SDA and SCL)	t _F	—	300	ns
Hold time (start condition)	t _{HDSTA}	0.6	—	μs
Setup time (rep.-start condition)	t _{SUSTA}	0.6	—	μs
Setup time (stop condition)	t _{SUSTO}	0.6	—	μs
Data setup time	t _{SUDAT}	100	—	ns
Data hold time	t _{HDDAT}	0	0.9	μs
Bus free time between Stop and Start condition	t _{BUF}	1.3		μs
Low period of the SCL clock	t _{LOW}	1.3		μs
High period of the SCL clock	t _{HIGH}	0.6		μs

3-1-4 2-wire serial communication register map

3-1-4-1 Description of 2-wire communication register map

In 2-wire serial communication, there is a 16-bit address space as follows. In IMX219PQH5-C, there are partially unreadable registers, which is described in Register map. If reading unreadable registers, the value to be read is 00h.

Table 10 2-wire Serial Communication Register Map Address Areas

Address Area	Description
0x0000 - 0x0fff	Configuration register
0x1000 - 0x1fff	Parameter limit register Read Only and Static resister
0x3000 - 0xffff	Manufacture specific register

3-1-5 Register Synchronization (Frame Bank)

Sequence for control of frame bank is explained in this section:

1. All registers on frame bank are latched by vertical synchronization (V-sync) signal.
2. Any change for registers on frame bank are reflected to functions in next frame (or following next frame) if the corresponding registers are updated.

Figures for sequences of frame bank are shown in following statements.

In case that user changes analog/digital gain and integration time only, we see no “no-data” term.

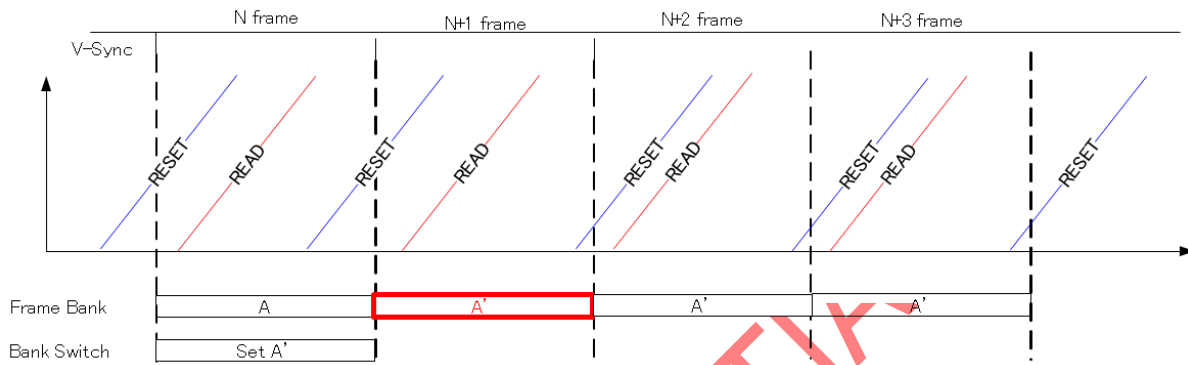

In case that user changes following registers, we may see a term in which we do not see any output from the sensor in addition to vertical blanking interval. From ISP's standing point, it seems that sensor has a bit longer vertical blanking interval.

Additional “no-data term” will be equal to coarse_integration_time + 20[H] if fast tracking mode register is activated.

List of registers is:

- Binning related registers (especially for analog binning)
- Sub-sampling registers (for vertical direction)
- Vertical image orientation registers
- Vertical ROI

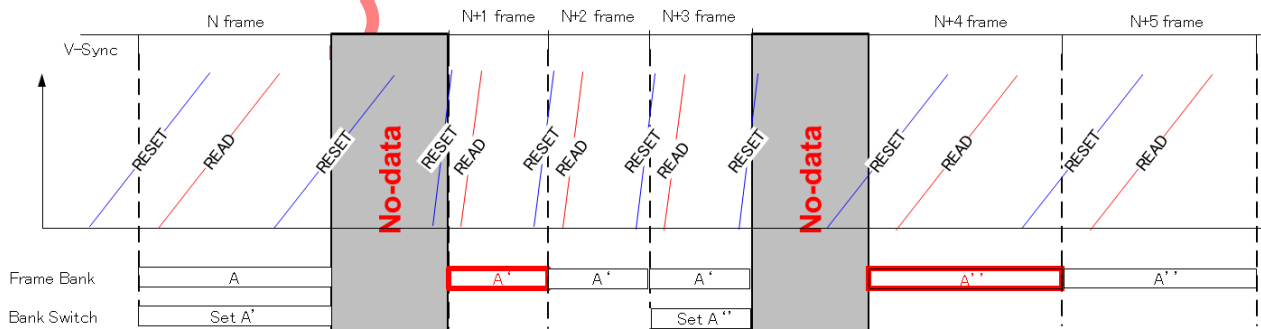

Fig. 19 Function Example for Frame Bank

**3-2 2-wire Serial Communication Register Map
(Configuration register, Parameter limit register)**

3-2-1 Configuration Registers – [0x0000-0x0FFF]

3-2-1-1 Status Registers – [0x0000-0x001B] (Read Only Dynamic Registers)

Index	Byte	Register Name	RW	Comment	Re-Time	Default (HEX)	Embd DL
0000	[7:0]	MODEL_ID[15:8]	RO	model id		02	
0001	[7:0]	MODEL_ID[7:0]	RO			19	
0004	[7:0]	Lot_ID[23:16]	RO-D	Lot_ID of the sensor Copied from NVM		XX	○
0005	[7:0]	Lot_ID[15:8]	RO-D			XX	○
0006	[7:0]	Lot_ID[7:0]	RO-D			XX	○
0007	[7:0]	Wafer_Num	RO-D	Wafer Number of the Sensor in the Lot. Value 0x01-0x19 is available.		XX	○
000D	[7:0]	Chip_Number[15:8]	RO-D	Chip ID in the wafer		XX	○
000E	[7:0]	Chip_Number[7:0]	RO-D			XX	○
0018	[7:0]	FRM_CNT[7:0]	RO-D			FF	○
0019	[7:0]	PX_ORDER	RO-D			01	○
001A	[1:0]	DT_PEDESTAL[9:8]	RO-D			0	○
001B	[7:0]	DT_PEDESTAL[7:0]	RO-D			40	○

CONFIDENTIAL

3-2-1-2 Frame Format Description – [0x0040-0x0047]

Index	Byte	Register Name	RW	Comment	Re-Time	Default (HEX)	Embd DL
0x0040	[7:0]	FRM_FMT_TYPE[7:0]	RO	frame_format_model_type		01	○
0x0041	[7:0]	FRM_FMT_SUBTYPE[7:0]	RO	frame_format_model_subtype		12	○
0x0042	[7:0]	FRM_FMT_DESC0[15:8]	RO-D	frame_format_descriptor_0		5C	○
0x0043	[7:0]	FRM_FMT_DESC0[7:0]				D0	○
0x0044	[7:0]	FRM_FMT_DESC1[15:8]	RO	frame_format_descriptor_1		10	○
0x0045	[7:0]	FRM_FMT_DESC1[7:0]				02	○
0x0046	[7:0]	FRM_FMT_DESC2[15:8]	RO-D	frame_format_descriptor_2		59	○
0x0047	[7:0]	FRM_FMT_DESC2[7:0]				A0	○

3-2-1-3 Analogue Gain Description Registers – [0x0080-0x0093]

Index	Byte	Register Name	RW	Comment	Re-Time	Default (HEX)	Embd DL
0x0080	—	—	—			00	
0x0081	[7:0]	analogue_gain_capability	RO	Analogue Gain Description Registers		0	
0x0082	—	Reserved	RO	Reserved		00	
0x0083	—	—	—			00	
0x0084	—	—	—			00	
0x0085	[7:0]	analogue_gain_code_min	RO-D	Analogue Gain Description Registers		00	
0x0086	[7:0]	analogue_gain_code_max	RO	Analogue Gain Description Registers possible to setup up to E8 (HEX)		00	
0x0087	[7:0]					E0	
0x0088	[7:0]	analogue_gain_code_step	RO	Analogue Gain Description Registers		00	
0x0089	[7:0]					01	
0x008A	[7:0]	analogue_gain_type	RO	Analogue Gain Description Registers		00	
0x008B	[7:0]					00	
0x008C	[7:0]	analogue_gain_m0	RO	Analogue Gain Description Registers		00	
0x008D	[7:0]					00	
0x008E	[7:0]	analogue_gain_c0	RO	Analogue Gain Description Registers		01	
0x008F	[7:0]					00	
0x0090	[7:0]	analogue_gain_m1	RO	Analogue Gain Description Registers		FF	
0x0091	[7:0]					FF	
0x0092	[7:0]	analogue_gain_c1	RO	Analogue Gain Description Registers		01	
0x0093	[7:0]					00	

3-2-1-4 Data Format Description – [0x00C0-0x00D1]

Index	Byte	Register Name	RW	Comment	Re-Time	Default (HEX)	Embd DL
0x00C0	[7:0]	DT_FMT_TYPE[7:0]	RO	data_format_model_type		01	○
0x00C1	[7:0]	DT_FMT_SUBTYPE[7:0]	RO	data_format_model_subtype		01	○
0x00C2	[7:0]	DT_FMT_DESC0[15:8]	RO	data_format_descriptor_0		0A	○
0x00C3	[7:0]	DT_FMT_DESC0[7:0]				08	○
0x00C4	[7:0]	DT_FMT_DESC1[15:8]	RO	data_format_descriptor_1		0A	○
0x00C5	[7:0]	DT_FMT_DESC1[7:0]				0A	○

3-2-2 Set-up Registers – [0x0100-0x0147]

3-2-2-1 General Set-up Registers – [0x0100-0x0106]

Index	Byte	Register Name	RW	Comment	Re-Time	Default (HEX)	Embd DL
0x0100	[4:0]	mode_select [4:0]	RW	Mode Select: 0: SW standby, 1: Streaming		00	○
0x0101	—	Reserved					
0x0102	—	Reserved					
0x0103	[0]	software_reset	RW	Software reset		00	○
0x0104	[0]	corrupted_frame_status	RO-D	corrupted frame status		00	○
0x0105	[0]	mask_corrupted_frames	RW	mask_corrupted_frames		01	○
0x0106	[0]	fast_standby_enable	RW	fast standby from streaming		00	○

CONFIDENTIAL

3-2-2-2 Output Set-up Registers – [0x0110-0x0147]

Index	Byte	Register Name	RW	Comment	Re-Time	Default (HEX)	Embd DL
0x0110	[1:0]	CSI_CH_ID	RW	CSI-2 channel ID		0	○
0x0111	[1:0]	CSI_SIG_MODE	RO	CSI-2 signalling mode		0	○
0x0114	[1:0]	CSI_LANE_MODE	RW	CSI_lane_mode 0: Reserved, 1: 2-Lane, 2: Reserved, 3: 4-Lane		3	○
0x0118	[0]	TCLK_POST[8]	RW	Global Timing Parameters		0	
0x0119	[7:0]	TCLK_POST[7:0]	RW	Global Timing Parameters		6F	
0x011A	[0]	THS_PREPARE[8]	RW	Global Timing Parameters		0	
0x011B	[7:0]	THS_PREPARE[7:0]	RW	Global Timing Parameters		2F	
0x011C	[0]	THS_ZERO_MIN[8]	RW	Global Timing Parameters		0	
0x011D	[7:0]	THS_ZERO_MIN[7:0]	RW	Global Timing Parameters		57	
0x011E	[0]	THS_TRAIL[8]	RW	Global Timing Parameters		0	
0x011F	[7:0]	THS_TRAIL[7:0]	RW	Global Timing Parameters		2F	
0x0120	[0]	TCLK_TRAIL_MIN[8]	RW	Global Timing Parameters		0	
0x0121	[7:0]	TCLK_TRAIL_MIN[7:0]	RW	Global Timing Parameters		2F	
0x0122	[0]	TCLK_PREPARE[8]	RW	Global Timing Parameters		0	
0x0123	[7:0]	TCLK_PREPARE[7:0]	RW	Global Timing Parameters		2F	
0x0124	[0]	TCLK_ZERO[8]	RW	Global Timing Parameters		0	
0x0125	[7:0]	TCLK_ZERO[7:0]	RW	Global Timing Parameters		BF	
0x0126	[0]	TLPX[8]	RW	Global Timing Parameters		0	
0x0127	[7:0]	TLPX[7:0]	RW	Global Timing Parameters		27	
0x0128	[0]	DPHY_CTRL	RW	MIPI Global timing setting 0: auto mode, 1: manual mode		1	
0x012A	[7:0]	EXCK_FREQ[15:8]	RW	INCK frequency [MHz]		0C	
0x012B	[7:0]	EXCK_FREQ[7:0]	RW	INCK frequency [MHz]		00	
0x0140	[7]	TEMPERATURE_EN	RW	start register to measure sensor temperature		0	○
	[6:0]	TEMPERATURE_VAL	RO-D	result of measurement of sensor temperature		XX	○
0x0142	[7:0]	READOUT_V_CNT [15:8]	RO-D	indicates current V-counter value for read-out		XX	○
0x0143	[7:0]	READOUT_V_CNT[7:0]				XX	○
0x0144	[0]	VSYNC_POL	RW	defines polarity of V-sync signal. 0: Lo-active, 1: Hi-active		0	
0x0145	—	Reserved					
0x0146	[0]	FLASH_POL	RW	defines polarity of flash strobe signal. 0: Hi-active, 1: Lo-active		0	
0x0147	[0]	VSYNC_TYPE	RW	Vsync type control 0: Vsync, 1: Reserved		0	

3-2-3 Frame Bank Control and Group “A” – [0x0150-0x018D]

3-2-3-1 Frame Bank Control Registers - [0x0150-0x0153]

Index	Byte	Register Name	RW	Comment	Re-Time	Default (HEX)	Embd DL
0x0150	[1]	FRAME_BANK_STATUS	RO-D	indicates frame bank applied in current frame		X	○
	[0]	FRAME_BANK_ENABLE	RW	defines Frame Bank to be applied in next frame (manual switching)		0	○
0x0151	[7:0]	FRAME_BANK_FRM_CNT	RO-D	frame counter value for frame bank switching.		XX	○
0x0152	[0]	FRAME_BANK_FAST_TRACKING	RW	When host changes frame_bank_enable register under ERS mode, sensor immediately stops current V-blanking and start new exposure.		0	○
0x0153	—	—	—				

3-2-3-2 Frame Bank Registers Group “A”- [0x0154-0x018D]

Index	Byte	Register Name	RW	Comment	Re-Time	Default (HEX)	Embd DL
0x0154	[7:0]	FRAME_DURATION_A	RW	defines number of frames to apply Frame Bank-A to actual function.	frame bank	00	○
0x0155	[0]	COMP_ENABLE_A	RW	compression 10 to 8 mode 0: Disable, 1: Enable	frame bank	0	○
0x0156	—	—	—				
0x0157	[7:0]	ANA_GAIN_GLOBAL_A	RW	analogue_gain_code_global	frame bank	00	○
0x0158	[3:0]	DIG_GAIN_GLOBAL_A [11:8]	RW	digital gain global	frame bank	1	○
0x0159	[7:0]	DIG_GAIN_GLOBAL_A [7:0]				00	
0x015A	[7:0]	COARSE_INTEGRATION_TIME_A[15:8]	RW	coarse_integration_time	frame bank	03	○
0x015B	[7:0]	COARSE_INTEGRATION_TIME_A[7:0]				E8	
0x015C	—	Reserved					
0x015D	[0]	SENSOR_MODE_A	RO	shutter mode register. 0: ERS, 1: reserved	frame bank	X	○
0x015E	—	Reserved					
0x015F	—	Reserved					
0x0160	[7:0]	FRM_LENGTH_A[15:8]	RW	frame_length_lines BINNING_MODE = 0,1,2 Unit: 1Lines BINNING_MODE = 3 Units: 2Lines	frame bank	0A	○
0x0161	[7:0]	FRM_LENGTH_A[7:0]				A8	
0x0162	[7:0]	LINE_LENGTH_A[15:8]	RW	line_length_pck Units: Pixels	frame bank	0D	○
0x0163	[7:0]	LINE_LENGTH_A[7:0]				78	
0x0164	[3:0]	X_ADD_STA_A[11:8]	RW	x_addr_start X-address of the top left corner of the visible pixel data Units: Pixels	frame bank	0	○
0x0165	[7:0]	X_ADD_STA_A[7:0]				00	
0x0166	[3:0]	X_ADD_END_A[11:8]	RW	x_addr_end X-address of the bottom right corner of the visible pixel data Units: Pixels	frame bank	C	○
0x0167	[7:0]	X_ADD_END_A[7:0]				CF	
0x0168	[3:0]	Y_ADD_STA_A[11:8]	RW	y_addr_start Y-address of the top left corner of the visible pixel data Units: Lines	frame bank	0	○
0x0169	[7:0]	Y_ADD_STA_A[7:0]				00	
0x016A	[3:0]	Y_ADD_END_A[11:8]	RW	y_addr_end Y-address of the bottom right corner of the visible pixel data Units: Pixels	frame bank	9	○
0x016B	[7:0]	Y_ADD_END_A[7:0]				9F	
0x016C	[3:0]	x_output_size[11:8]	RW	output image size (X-direction) Width of image data output from the sensor module Units: Pixels	frame bank	C	○
0x016D	[7:0]	x_output_size[7:0]				D0	
0x016E	[3:0]	y_output_size[11:8]	RW	output image size (Y-direction) Height of image data output from the sensor module Units: Lines	frame bank	9	○
0x016F	[7:0]	y_output_size[7:0]				A0	

Index	Byte	Register Name	RW	Comment	Re-Time	Default (HEX)	Embd DL
0x0170	[2:0]	X_ODD_INC_A	RW	x_odd_inc Increment for odd pixels 1, 3	frame bank	1	○
0x0171	[2:0]	Y_ODD_INC_A		y_odd_inc Increment for odd pixels 1, 3	frame bank	1	○
0x0172	[0]	IMG_ORIENTATION_A[0]	RW	image_orientation (for both direction) bit[0]: hori. direction bit[1]: vert. direction	frame bank	0	○
	[1]	IMG_ORIENTATION_A[1]	RW			0	○
0x0173	—	Reserved					
0x0174	[1:0]	BINNING_MODE_H_A	RW	defines binning mode (H-direction). 0: no-binning, 1: x2-binning, 2: x4-binning, 3: x2-analog (special) binning	frame bank	0	○
0x0175	[1:0]	BINNING_MODE_V_A	RW	defines binning mode (V-direction). 0: no-binning, 1: x2-binning, 2: x4-binning, 3: x2-analog (special) binning	frame bank	0	○
0x0176	[0]	BINNING_CAL_MODE_H_A	RW	defines binning mode (H-direction). 0 :average, 1: sum	frame bank	0	○
0x0177	[0]	BINNING_CAL_MODE_V_A	RW	defines binning mode (V-direction). 0: average, 1: sum	frame bank	0	○
0x0189	[7:0]	ANA_GAIN_GLOBAL_SHORT_A	RW	Analog gain (short exposure)	frame bank	00	○
0x018A	[7:0]	COARSE_INTEG_TIME_SHORT_A [15:8]	RW	Coarse integ time (short exposure)	frame bank	01	○
0x018B	[7:0]	COARSE_INTEG_TIME_SHORT_A [7:0]				F4	○
0x018C	[7:0]	CSI_DATA_FORMAT_A [15:8]	RW	CSI-2 data format	frame bank	0A	○
0x018D	[7:0]	CSI_DATA_FORMAT_A [7:0]				0A	○

CONFIDENTIAL

3-2-4 Frame Bank Control Group “B” – [0x0254-0x028D]

3-2-4-1 Frame Bank Registers Group “B”- [0x0254-0x028D]

Index	Byte	Register Name	RW	Comment	Re-Time	Default (HEX)	Embd DL
0x0254	[7:0]	FRAME_DURATION_B	RW	defines number of frames to apply FrameBank-A to actual function.	frame bank	00	○
0x0255	[0]	COMP_ENABLE_B	RW	compression 10 to 8 mode 0: Disable, 1: Enable	frame bank	0	○
0x0256	—	—	—				
0x0257	[7:0]	ANA_GAIN_GLOBAL_B	RW	analogue_gain_code_global	frame bank	00	○
0x0258	[3:0]	DIG_GAIN_GLOBAL_B[11:8]	RW	digital gain global	frame bank	1	○
0x0259	[7:0]	DIG_GAIN_GLOBAL_B[7:0]				00	○
0x025A	[7:0]	COARSE_INTEGRATION_TIME_B[15:8]	RW	coarse_integration_time	frame bank	03	○
0x025B	[7:0]	COARSE_INTEGRATION_TIME_B[7:0]	RW			E8	○
0x025C	—	Reserved					○
0x025D	[0]	SENSOR_MODE_B	RO	shutter mode register. 0: ERS, 1: reserved	frame bank	0	○
0x025E	—	Reserved					
0x025F	—	Reserved					
0x0260	[7:0]	FRM_LENGTH_B[15:8]	RW	frame_length_lines BINNING_MODE = 0,1,2 Unit:1Lines BINNING_MODE = 3 Units:2Lines	frame bank	0A	○
0x0261	[7:0]	FRM_LENGTH_B[7:0]				A8	○
0x0262	[7:0]	LINE_LENGTH_B[15:8]	RW	line_length_pck Units: Pixels	frame bank	0D	○
0x0263	[7:0]	LINE_LENGTH_B[7:0]				78	○
0x0264	[3:0]	X_ADD_STA_B[11:8]	RW	x_addr_start X-address of the top left corner of the visible pixel data Units: Pixels	frame bank	0	○
0x0265	[7:0]	X_ADD_STA_B[7:0]				00	○
0x0266	[3:0]	X_ADD_END_B[11:8]	RW	x_addr_end X-address of the bottom right corner of the visible pixel data Units: Pixels	frame bank	C	○
0x0267	[7:0]	X_ADD_END_B[7:0]				CF	○
0x0268	[3:0]	Y_ADD_STA_B[11:8]	RW	y_addr_start Y-address of the top left corner of the visible pixel data Units: Lines	frame bank	0	○
0x0269	[7:0]	Y_ADD_STA_B[7:0]				00	○
0x026A	[3:0]	Y_ADD_END_B[11:8]	RW	y_addr_end X-address of the bottom right corner of the visible pixel data Units: Pixels	frame bank	9	○
0x026B	[7:0]	Y_ADD_END_B[7:0]				9F	○
0x026C	[3:0]	x_output_size[11:8]	RW	output image size (Y-direction) Height of image data output from the sensor module Units: Lines	frame bank	C	○
0x026D	[7:0]	x_output_size[7:0]				D0	○
0x026E	[3:0]	y_output_size[11:8]	RW	output image size (Y-direction) Height of image data output from the sensor module Units: Lines	frame bank	9	○
0x026F	[7:0]	y_output_size[7:0]				A0	○
0x0270	[2:0]	X_ODD_INC_B	RW	x_odd_inc Increment for odd pixels 1, 3	frame bank	1	○
0x0271	[2:0]	Y_ODD_INC_B	RW	y_odd_inc Increment for odd pixels 1, 3	frame bank	1	○
0x0272	[0]	IMG_ORIENTATION_B[0]	RW	image_orientation bit[0]: hori. direction, bit[1]: vert. direction	frame bank	0	○
	[1]	IMG_ORIENTATION_B[1]	RW			0	○
0x0273	—	Reserved					
0x0274	[1:0]	BINNING_MODE_H_B	RW	defines binning mode (H-direction). 0: no-binning, 1: x2-binning, 2: x4-binning, 3: x2-analog (special) binning	frame bank	0	○
0x0275	[1:0]	BINNING_MODE_V_B	RW	defines binning mode (V-direction). 0: no-binning, 1: x2-binning, 2: x4-binning, 3: x2-analog (special) binning	frame bank	0	○
0x0276	[0]	BINNING_CAL_MODE_H_B	RW	defines binning mode (H-direction). 0: average, 1: sum	frame bank	0	○
0x0277	[0]	BINNING_CAL_MODE_V_B	RW	defines binning mode (V-direction). 0: average, 1: sum	frame bank	0	○
0x0289	[7:0]	ANA_GAIN_GLOBAL_SHORT_B	RW	Analog gain (short exposure)	frame bank	00	○
0x028A	[7:0]	COARSE_INTEG_TIME_SHORT_B [15:8]	RW	Coarse integ time (short exposure)	frame bank	01	○

Index	Byte	Register Name	RW	Comment	Re-Time	Default (HEX)	Embd DL
0x028B	[7:0]	COARSE_INTEG_TIME_SHORT_B [7:0]				F4	○
0x028C	[7:0]	CSI_DATA_FORMAT_B [15:8]	RW	CSI-2 data format	frame bank	0A	○
0x028D	[7:0]	CSI_DATA_FORMAT_B [7:0]				0A	○

3-2-5 Set-up Registers – [0x0300-0x0627]

3-2-5-1 Clock Set-up Registers – [0x0300-0x0313]

Index	Byte	Register Name	RW	Comment	Re-Time	Default (HEX)	Embd DL
0x0300	—	—	RW				
0x0301	[4:0]	VTPXCK_DIV	RW	vt_pix_clk_div Video Timing Pixel Clock Divider Value		05	○
0x0302	—	—	RW				
0x0303	[1:0]	VTSYCK_DIV	RW	vt_sys_clk_div Video Timing System Clock Divider Value		1	○
0x0304	[7:0]	PREPLLCK_VT_DIV	RW	pre_pll_clk_vt_div Pre PLL clock Video Timing System Divider Value values: Integer-N mode : prepllck_vt_div = 1, 2, 3 For example 1: EXCK_FREQ 6 MHz to 12 MHz 2: EXCK_FREQ 12 MHz to 24 MHz 3: EXCK_FREQ 24 MHz to 27 MHz	V-sync	2	○
0x0305	[7:0]	PREPLLCK_OP_DIV	RW	pre_pll_clk_op_div Pre PLL clock Output System Divider Value values: Integer-N mode : prepllck_vt_div = 1, 2, 3 For example 1: EXCK_FREQ 6 MHz to 12 MHz 2: EXCK_FREQ 12 MHz to 24 MHz 3: EXCK_FREQ 24 MHz to 27 MHz	V-sync	2	○
0x0306	[2:0]	PLL_VT_MPY[10:8]	RW	pll_vt_multiplier PLL Video Timing System multiplier Value	V-sync	0	○
0x0307	[7:0]	PLL_VT_MPY[7:0]				75	○
0x0308	—	—	—				
0x0309	[4:0]	OPPCK_DIV	RW	op_pix_clk_div Output Pixel Clock Divider Value		0A	○
0x030A	—	—	RW				
0x030B	[1:0]	OPSYCK_DIV	RW	op_sys_clk_div Output System Clock Divider Value		1	○
0x030C	[2:0]	PLL_OP_MPY[10:8]	RW	pll_op_multiplier PLL Output System multiplier Value	V-sync	0	○
0x030D	[7:0]	PLL_OP_MPY[7:0]				75	○

3-2-5-2 Flash Control (ERS) Registers – [0x0320-0x0338]

Index	Byte	Register Name	RW	Comment	Re-Time	Default (HEX)	Embd DL
0x0320	[0]	FLASH_START_TRIG	RW	Flash strobe start trigger for ERS mode.		0	
0x0321	[0]	FLASH_STATUS	RO-D	Flash status signal		0	o
0x0322	[7:0]	FLASH_STROBE_DIV[7:0]	RW	Internal divider for checking timing of flash strobe.		01	
0x0324	[1:0]	FLASH_STROBE_OUTPUT_ENABLE	RW	Flash strobe output enable. [0] ERS mode [1] reserved		0	
0x032E	[1:0]	FLASH_MODE	RW	Flash strobe mode setting for ERS mode. 0: shutter sync (single), 1: shutter sync (continuous mode), 2: vcnt sync (single)		0	
0x032F	[0]	FLASH_REF_MODE	RW	Flash strobe reference point setting for ERS mode. exposure (0) or read-out (1)		0	
0x0330	[7:0]	FLASH_STROBE_REF[15:8]	RW	Start point of flash strobe control.		00	
0x0331	[7:0]	FLASH_STROBE_REF[7:0]				00	
0x0332	[7:0]	FLASH_STROBE_LATENCY_RS[15:8]	RW	Latency control of flash strobe in ERS mode		00	
0x0333	[7:0]	FLASH_STROBE_LATENCY_RS[7:0]				00	
0x0334	[7:0]	FLASH_STROBE_HI_PERIOD_RS[15:8]	RW	active period of flash strobe in ERS mode		00	
0x0335	[7:0]	FLASH_STROBE_HI_PERIOD_RS[7:0]				01	
0x0336	[7:0]	FLASH_STROBE_LO_PERIOD_RS[15:8]	RW	interval between active period of flash strobe in ERS mode		00	
0x0337	[7:0]	FLASH_STROBE_LO_PERIOD_RS[7:0]				01	
0x0338	[7:0]	FLASH_STROBE_COUNT_RS	RW	Number of events in which flash strobe is asserted.		01	

3-2-5-3 Even increment Registers – [0x0381-0x0383]

Index	Byte	Register Name	RW	Comment	Re-Time	Default (HEX)	Embd DL
0x0381	[2:0]	X_EVN_INC	RO	x_even_inc Increment for even pixels		01	
0x0382	—	—	—				
0x0383	[2:0]	Y_EVN_INC	RO	y_even_inc Increment for even pixels		01	

3-2-5-4 Integration Time Registers – [0x0388-0x0389]

Index	Byte	Register Name	RW	Comment	Re-Time	Default (HEX)	Embd DL
0x0388	[7:0]	FINE_INTEG_TIME[15:8]	RO-D	fine_integration_time		01	
0x0389	[7:0]	FINE_INTEG_TIME[7:0]				F4	

3-2-5-5 Test Pattern Registers – [0x0600-0x0627]

Index	Byte	Register Name	RW	Comment	Re-Time	Default (HEX)	Embd DL
0x0600	[0]	test_pattern_mode	RW	test_pattern_mode	V-sync	0	
0x0601	[7:0]					00	
0x0602	[1:0]	TD_R[9:8]	RW	test_data_red		0	
0x0603	[7:0]	TD_R[7:0]				00	
0x0604	[1:0]	TD_GR[9:8]	RW	test_data_greenR		0	
0x0605	[7:0]	TD_GR[7:0]				00	
0x0606	[1:0]	TD_B[9:8]	RW	test_data_blue		0	
0x0607	[7:0]	TD_B[7:0]				00	
0x0608	[1:0]	TD_GB[9:8]	RW	test_data_greenB		0	
0x0609	[7:0]	TD_GB[7:0]				00	
0x060A	[7:0]	H_CUR_WIDTHH[15:8]	RW	horizontal_cursor_width		0	
0x060B	[7:0]	H_CUR_WIDTHH[7:0]				00	
0x060C	[7:0]	H_CUR_POS[15:8]	RW	horizontal_cursor_position		0	
0x060D	[7:0]	H_CUR_POS[7:0]				00	
0x060E	[7:0]	V_CUR_WIDTHH[15:8]	RW	vertical_cursor_width		0	
0x060F	[7:0]	V_CUR_WIDTHH[7:0]				00	
0x0610	[7:0]	V_CUR_POS[15:8]	RW	vertical_cursor_position		0	
0x0611	[7:0]	V_CUR_POS[7:0]				00	
0x0612	—	—	—				
0x0620	[3:0]	TP_WINDOW_X_OFFSET[11:8]	RW	test_pattern_window_x_offset		0	
0x0621	[7:0]	TP_WINDOW_X_OFFSET[7:0]				00	
0x0622	[3:0]	TP_WINDOW_Y_OFFSET[11:8]	RW	test_pattern_window_y_offset		0	
0x0623	[7:0]	TP_WINDOW_Y_OFFSET[7:0]				00	
0x0624	[3:0]	TP_WINDOW_WIDTH[11:8]	RW	test_pattern_window_width		0	
0x0625	[7:0]	TP_WINDOW_WIDTH[7:0]				00	
0x0626	[3:0]	TP_WINDOW_HEIGHT[11:8]	RW	test_pattern_window_height		0	
0x0627	[7:0]	TP_WINDOW_HEIGHT[7:0]				00	

3-3 Parameter Limit Registers – [0x1000-0x1FFF] (Read Only and Static)

3-3-1 Integration Time and Gain Parameter Limit Registers – [0x1000-0x1301]

3-3-1-1 Integration Time Parameter Limit Registers – [0x1000-0x1007]

Index	Byte	Register Name	RW	Comment	Re-Time	Default (HEX)	Embd DL
0x1000	—	integration_time_capability	RO	0 – coarse integration but NO fine integration		0	
0x1001	[0]						
0x1002	—	Reserved	RO				
0x1003	—						
0x1004	[7:0]	coarse_integration_time_min	RO	Format: 16-bits unsigned integer		00	
0x1005	[7:0]					01	
0x1006	[7:0]	coarse_integration_time_max_margin	RO	(Current frame length – current max coarse exp) Format: 16-bits unsigned integer		00	
0x1007	[7:0]					04	

3-3-1-2 Digital Gain Parameter Limit Registers – [0x1080-0x1089]

Index	Byte	Register Name	RW	Comment	Re-Time	Default (HEX)	Embd DL
0x1080	—	—	RO	1 – per channel digital gain *		1	
0x1081	[0]	digital_gain_capability					
0x1082	—	Reserved	RO			00	
0x1083	—					00	
0x1084	[7:0]	digital_gain_min	RO	Minimum recommended digital gain value Format: 16-bit unsigned 8.8 fixed point number		01	
0x1085	[7:0]					00	
0x1086	[7:0]	digital_gain_max	RO	Maximum recommended digital gain value Format: 16-bit unsigned 8.8 fixed point number		0F	
0x1087	[7:0]					FF	
0x1088	[7:0]	digital_gain_step_size	RO	Digital gain step size Format: 16-bit unsigned 8.8 fixed point number		00	
0x1089	[7:0]					01	

* Only a setup common to channel

3-3-1-3 Pre-PLL and PLL Clock Set-up Capability Registers – [0x1100-0x111F]

Index	Byte	Register Name	RW	Comment	Re-Time	Default (HEX)	Embd DL
0x1100	[7:0]	min_ext_clk_freq_mhz	RO	Minimum external clock frequency Format: IEEE 32-bit float Units: MHz 6 MHz (= min_ext_clk_freq_mhz)		40	
0x1101	[7:0]					C0	
0x1102	[7:0]					00	
0x1103	[7:0]					00	
0x1104	[7:0]	max_ext_clk_freq_mhz	RO	Maximum external clock frequency Format: IEEE 32-bit float Units: MHz 27 MHz (= max_ext_clk_freq_mhz)		41	
0x1105	[7:0]					D8	
0x1106	[7:0]					00	
0x1107	[7:0]					00	
0x1108	[7:0]	min_pre_pll_clk_div	RO	Minimum Pre PLL divider value Format: 16-bit unsigned integer		00	
0x1109	[7:0]					01	
0x110A	[7:0]	max_pre_pll_clk_div	RO	Maximum Pre PLL divider value Format: 16-bit unsigned integer		00	
0x110B	[7:0]					0D	
0x110C	[7:0]	min_pll_ip_freq_mhz	RO	Minimum PLL input clock frequency Format: IEEE 32-bit float Units: MHz 6 MHz		40	
0x110D	[7:0]					C0	
0x110E	[7:0]					00	
0x110F	[7:0]					00	
0x1110	[7:0]	max_pll_ip_freq_mhz	RO	Maximum PLL input clock frequency Format: IEEE 32-bit float Units: MHz 27 MHz (= max_ext_clk_freq_mhz)		41	
0x1111	[7:0]					D8	
0x1112	[7:0]					00	
0x1113	[7:0]					00	
0x1114	[7:0]	min_pll_multiplier	RO	Minimum PLL multiplier Format: 16-bit unsigned integer		00	
0x1115	[7:0]					08	
0x1116	[7:0]	max_pll_multiplier	RO	Maximum PLL Multiplier Format: 16-bit unsigned integer		07	
0x1117	[7:0]					FF	
0x1118	[7:0]	min_pll_op_freq_mhz	RO	Minimum PLL output clock frequency Format: IEEE 32-bit float Units: MHz 432 MHz		43	
0x1119	[7:0]					D8	
0x111A	[7:0]					00	
0x111B	[7:0]					00	
0x111C	[7:0]	max_pll_op_freq_mhz	RO	Maximum PLL output clock frequency Format: IEEE 32-bit float Units: MHz 916 MHz		44	
0x111D	[7:0]					65	
0x111E	[7:0]					00	
0x111F	[7:0]					00	

3-3-1-4 Read Domain Clock Set-up Capability Registers – [0x1120-0x1137]

Index	Byte	Register Name	RW	Comment	Re-Time	Default (HEX)	Embd DL
0x1120	[7:0]	min_vt_sys_clk_div	RO	Minimum video timing system clock divider value Format: 16-bit unsigned integer		00	
0x1121	[7:0]					01	
0x1122	[7:0]	max_vt_sys_clk_div	RO	Maximum video timing system clock divider value Format: 16-bit unsigned integer		00	
0x1123	[7:0]					02	
0x1124	[7:0]	min_vt_sys_clk_freq_mhz	RO	Minimum video timing system clock frequency Format: IEEE 32-bit float Units: MHz 200 MHz		43	
0x1125	[7:0]					48	
0x1126	[7:0]					00	
0x1127	[7:0]					00	
0x1128	[7:0]	max_vt_sys_clk_freq_mhz	RO	Maximum video timing system clock frequency Format: IEEE 32-bit float Units: MHz 700 MHz		44	
0x1129	[7:0]					2F	
0x112A	[7:0]					00	
0x112B	[7:0]					00	
0x112C	[7:0]	min_vt_pix_clk_freq_mhz	RO	Minimum video timing pixel clock frequency Format: IEEE 32-bit float Units: MHz 80 MHz		42	
0x112D	[7:0]					A0	
0x112E	[7:0]					00	
0x112F	[7:0]					00	
0x1130	[7:0]	max_vt_pix_clk_freq_mhz	RO	Maximum video timing pixel clock frequency Format: IEEE 32-bit float Units: MHz 140 MHz		43	
0x1131	[7:0]					0C	
0x1132	[7:0]					00	
0x1133	[7:0]					00	
0x1134	[7:0]	min_vt_pix_clk_div	RO	Minimum video timing pixel clock divider value Format: 16-bit unsigned integer		00	
0x1135	[7:0]					05	
0x1136	[7:0]	max_vt_pix_clk_div	RO	Maximum video timing pixel clock divider value Format: 16-bit unsigned integer		00	
0x1137	[7:0]					05	

3-3-1-5 Frame Timing Parameter Limit Registers – [0x1140-0x114B]

Index	Byte	Register Name	RW	Comment	Re-Time	Default (HEX)	Embd DL
0x1140	[7:0]	min_frame_length_lines	RO	Minimum Frame Length allowed. Value both sensor dependent Format: 16-bit unsigned integer Units: Lines		01	
0x1141	[7:0]					00	
0x1142	[7:0]	max_frame_length_lines	RO	Maximum possible number of lines per Frame. Value sensor dependent Format: 16-bit unsigned integer Units: Lines		FF	
0x1143	[7:0]					FE	
0x1144	[7:0]	min_line_length_pck	RO	Minimum Line Length allowed. Value sensor dependent. But setup is possible at a smaller value * Format: 16-bit unsigned integer Units: Pixel Clock		0D	
0x1145	[7:0]					78	
0x1146	[7:0]	max_line_length_pck	RO	Maximum possible number of pixel clocks per line. Value sensor dependent Format: 16-bit unsigned integer Units: Pixel Clock		7F	
0x1147	[7:0]					F0	
0x1148	[7:0]	min_line_blanking_pck	RO	Minimum line blanking time in pixel clocks Format: 16-bit unsigned integer Units: Pixel Clock		00	
0x1149	[7:0]					A8	
0x114A	[7:0]	min_frame_blanking_lines	RO	Minimum frame blanking in video timing lines Format: 16-bit unsigned integer Units: Pixel Clock		00	
0x114B	[7:0]					20	

* possible to setup up to D60 (HEX)

3-3-1-6 Output Clock Set-up Capability Registers – [0x1160-0x1177]

Index	Byte	Register Name	RW	Comment	Re-Time	Default (HEX)	Embd DL
0x1160	[7:0]	min_op_sys_clk_div	RO	Minimum output system clock divider value Format: 16-bit unsigned integer		00	
0x1161	[7:0]					01	
0x1162	[7:0]	max_op_sys_clk_div	RO	Maximum output system clock divider value Format: 16-bit unsigned integer		00	
0x1163	[7:0]					02	
0x1164	[7:0]	min_op_sys_clk_freq_mhz	RO	Minimum output system clock frequency Format: IEEE 32-bit float Units: MHz 200 MHz		43	
0x1165	[7:0]					48	
0x1166	[7:0]					00	
0x1167	[7:0]					00	
0x1168	[7:0]	max_op_sys_clk_freq_mhz	RO	Maximum output system clock frequency Format: IEEE 32-bit float Units: MHz 916 MHz		44	
0x1169	[7:0]					65	
0x116A	[7:0]					20	
0x116B	[7:0]					00	
0x116C	[7:0]	min_op_pix_clk_freq_mhz	RO	Minimum output pixel clock frequency Format: IEEE 32-bit float Units: MHz 20 MHz		41	
0x116D	[7:0]					A0	
0x116E	[7:0]					00	
0x116F	[7:0]					00	
0x1170	[7:0]	max_op_pix_clk_freq_mhz	RO	Maximum output pixel clock frequency Format: IEEE 32-bit float Units: MHz 114.5 MHz		42	
0x1171	[7:0]					E5	
0x1172	[7:0]					00	
0x1173	[7:0]					00	
0x1174	[7:0]	min_op_pix_clk_div	RO	Minimum output pixel clock divider value Format: 16-bit unsigned integer		00	
0x1175	[7:0]					08	
0x1176	[7:0]	max_op_pix_clk_div	RO	Maximum output pixel clock divider value Format: 16-bit unsigned integer		00	
0x1177	[7:0]					0A	

3-3-1-7 Image Size Parameter Limit Registers – [0x1180-0x118F]

Index	Byte	Register Name	RW	Comment	Re-Time	Default (HEX)	Embd DL
0x1180	[7:0]	x_addr_min	RO	Minimum X-address of the addressable pixel array Format: 16-bit unsigned integer Value: Always 0		00	
0x1181	[7:0]					00	
0x1182	[7:0]	y_addr_min	RO	Minimum Y-address of the addressable pixel array Format: 16-bit unsigned integer Value: Always 0		00	
0x1183	[7:0]					00	
0x1184	[7:0]	x_addr_max	RO	Maximum X-address of the addressable pixel array Format: 16-bit unsigned integer		0C	
0x1185	[7:0]					CF	
0x1186	[7:0]	y_addr_max	RO	Maximum Y-address of the addressable pixel array Format: 16-bit unsigned integer		09	
0x1187	[7:0]					9F	
0x1188	[7:0]	min_x_output_size	RO	Minimum x output size in pixels Format: 16-bit unsigned integer		01	
0x1189	[7:0]					00	
0x118A	[7:0]	min_y_output_size	RO	Minimum y output size in pixels Format: 16-bit unsigned integer		01	
0x118B	[7:0]					00	
0x118C	[7:0]	max_x_output_size	RO	Maximum x output size in pixels Format: 16-bit unsigned integer		0C	
0x118D	[7:0]					D0	
0x118E	[7:0]	max_y_output_size	RO	Maximum y output size in pixels Format: 16-bit unsigned integer		09	
0x118F	[7:0]					A0	

3-3-1-8 Sub-Sampling Parameter Limit Registers – [0x11C0-0x11C7]

Index	Byte	Register Name	RW	Comment	Re-Time	Default (HEX)	Embd DL
0x11C0	[7:0]	min_even_inc	RO	Minimum Increment for even pixels Format: 16-bit unsigned integer (static)		00	
0x11C1	[7:0]					01	
0x11C2	[7:0]	max_even_inc	RO	Maximum increment for even pixels Format: 16-bit unsigned integer (static)		00	
0x11C3	[7:0]					01	
0x11C4	[7:0]	min_odd_inc	RO	Minimum Increment for odd pixels Format: 16-bit unsigned integer (static)		00	
0x11C5	[7:0]					01	
0x11C6	[7:0]	max_odd_inc	RO	Maximum Increment for odd pixels Format: 16-bit unsigned integer (static)		00	
0x11C7	[7:0]					03	

3-3-1-9 Image Compression Capability Registers – [0x1300-0x1301]

Index	Byte	Register Name	RW	Comment	Re-Time	Default (HEX)	Embd DL
0x1300	—	—	—				
0x1301	[0]	compression_capability	RO	compression_capability (support comp10to8)		1	

3-4 Manufacturer Specific Registers – [0x3000-0x5FFF]

To access this address area, it is necessary to send command sequence as below.

Table 11 Access command sequence

Seq. No.	Address (Hex)	data
1	30EB	05
2	30EB	0C
3	300A	FF
4	300B	FF
5	30EB	05
6	30EB	09

Register [0x3200-0x3243]

Index (HEX)	Bit	Register Name	RW	Comment	Re-Timed	Default (HEX)
3200	[2:0]	OTPIF_CTRL	RW	OTP I/F control register [0] enable [1]R/W [2]error clear		0
3201	[1:0]	OTPIF_STATUS	RO-D	OTP I/F status; [0] read ready [1] write ready		0
3202	[7:0]	OTPIF_PAGE_SELECT	RW	otpif_page_select		0
3204	[7:0]	OTPIF_DT_0	RW	otpif_data_0		00
3205	[7:0]	OTPIF_DT_1	RW	otpif_data_1		00
3206	[7:0]	OTPIF_DT_2	RW	otpif_data_2		00
3207	[7:0]	OTPIF_DT_3	RW	otpif_data_3		00
3208	[7:0]	OTPIF_DT_4	RW	otpif_data_4		00
3209	[7:0]	OTPIF_DT_5	RW	otpif_data_5		00
320A	[7:0]	OTPIF_DT_6	RW	otpif_data_6		00
320B	[7:0]	OTPIF_DT_7	RW	otpif_data_7		00
320C	[7:0]	OTPIF_DT_8	RW	otpif_data_8		00
320D	[7:0]	OTPIF_DT_9	RW	otpif_data_9		00
320E	[7:0]	OTPIF_DT_10	RW	otpif_data_10		00
320F	[7:0]	OTPIF_DT_11	RW	otpif_data_11		00
3210	[7:0]	OTPIF_DT_12	RW	otpif_data_12		00
3211	[7:0]	OTPIF_DT_13	RW	otpif_data_13		00
3212	[7:0]	OTPIF_DT_14	RW	otpif_data_14		00
3213	[7:0]	OTPIF_DT_15	RW	otpif_data_15		00
3214	[7:0]	OTPIF_DT_16	RW	otpif_data_16		00
3215	[7:0]	OTPIF_DT_17	RW	otpif_data_17		00
3216	[7:0]	OTPIF_DT_18	RW	otpif_data_18		00
3217	[7:0]	OTPIF_DT_19	RW	otpif_data_19		00
3218	[7:0]	OTPIF_DT_20	RW	otpif_data_20		00
3219	[7:0]	OTPIF_DT_21	RW	otpif_data_21		00
321A	[7:0]	OTPIF_DT_22	RW	otpif_data_22		00
321B	[7:0]	OTPIF_DT_23	RW	otpif_data_23		00
321C	[7:0]	OTPIF_DT_24	RW	otpif_data_24		00
321D	[7:0]	OTPIF_DT_25	RW	otpif_data_25		00
321E	[7:0]	OTPIF_DT_26	RW	otpif_data_26		00
321F	[7:0]	OTPIF_DT_27	RW	otpif_data_27		00
3220	[7:0]	OTPIF_DT_28	RW	otpif_data_28		00

Index (HEX)	Bit	Register Name	RW	Comment	Re-Timed	Default (HEX)
3221	[7:0]	OTPIF_DT_29	RW	otpif_data_29		00
3222	[7:0]	OTPIF_DT_30	RW	otpif_data_30		00
3223	[7:0]	OTPIF_DT_31	RW	otpif_data_31		00
3224	[7:0]	OTPIF_DT_32	RW	otpif_data_32		00
3225	[7:0]	OTPIF_DT_33	RW	otpif_data_33		00
3226	[7:0]	OTPIF_DT_34	RW	otpif_data_34		00
3227	[7:0]	OTPIF_DT_35	RW	otpif_data_35		00
3228	[7:0]	OTPIF_DT_36	RW	otpif_data_36		00
3229	[7:0]	OTPIF_DT_37	RW	otpif_data_37		00
322A	[7:0]	OTPIF_DT_38	RW	otpif_data_38		00
322B	[7:0]	OTPIF_DT_39	RW	otpif_data_39		00
322C	[7:0]	OTPIF_DT_40	RW	otpif_data_40		00
322D	[7:0]	OTPIF_DT_41	RW	otpif_data_41		00
322E	[7:0]	OTPIF_DT_42	RW	otpif_data_42		00
322F	[7:0]	OTPIF_DT_43	RW	otpif_data_43		00
3230	[7:0]	OTPIF_DT_44	RW	otpif_data_44		00
3231	[7:0]	OTPIF_DT_45	RW	otpif_data_45		00
3232	[7:0]	OTPIF_DT_46	RW	otpif_data_46		00
3233	[7:0]	OTPIF_DT_47	RW	otpif_data_47		00
3234	[7:0]	OTPIF_DT_48	RW	otpif_data_48		00
3235	[7:0]	OTPIF_DT_49	RW	otpif_data_49		00
3236	[7:0]	OTPIF_DT_50	RW	otpif_data_50		00
3237	[7:0]	OTPIF_DT_51	RW	otpif_data_51		00
3238	[7:0]	OTPIF_DT_52	RW	otpif_data_52		00
3239	[7:0]	OTPIF_DT_53	RW	otpif_data_53		00
323A	[7:0]	OTPIF_DT_54	RW	otpif_data_54		00
323B	[7:0]	OTPIF_DT_55	RW	otpif_data_55		00
323C	[7:0]	OTPIF_DT_56	RW	otpif_data_56		00
323D	[7:0]	OTPIF_DT_57	RW	otpif_data_57		00
323E	[7:0]	OTPIF_DT_58	RW	otpif_data_58		00
323F	[7:0]	OTPIF_DT_59	RW	otpif_data_59		00
3240	[7:0]	OTPIF_DT_60	RW	otpif_data_60		00
3241	[7:0]	OTPIF_DT_61	RW	otpif_data_61		00
3242	[7:0]	OTPIF_DT_62	RW	otpif_data_62		00
3243	[7:0]	OTPIF_DT_63	RW	otpif_data_63		00

3-5 Frame Bank A and Bank B specific output samples

Specific output examples are shown on the following pages.

Frame Bank A mode

Addr (Hex)	Register Name	in Byte (Hex)
<i>Line1 (Embedded Data Line)</i>		
0x0000	MODEL_ID[15:8]	X2
0x0001	MODEL_ID[7:0]	19
0x0002	FABRICATION_TOP	XX
0x0004	LOT_ID_TOP[23:16]	XX
0x0005	LOT_ID_TOP[15:8]	XX
0x0006	LOT_ID_TOP[7:0]	XX
0x0007	WAFER_NUM_TOP	XX
0x000D	CHIP_NUMBER[15:8]	XX
0x000E	CHIP_NUMBER[7:0]	XX
0x000F	PROCESS_VERSION	XX
0x0011	ROM_ID	XX
0x0018	FRM_CNT[7:0]	XX
0x0019	PX_ORDER	XX
0x001A	DT_PEDESTAL[9:8]	XX
0x001B	DT_PEDESTAL[7:0]	XX
0x0040	FRM_FMT_TYPE[7:0]	XX
0x0041	FRM_FMT_SUBTYPE[7:0]	12
0x0042	FRM_FMT_DESC0[15:8]	XX
0x0043	FRM_FMT_DESC0[7:0]	XX
0x0044	FRM_FMT_DESC1[15:8]	XX
0x0045	FRM_FMT_DESC1[7:0]	XX
0x0046	FRM_FMT_DESC2[15:8]	XX
0x0047	FRM_FMT_DESC2[7:0]	XX
0x0100	MODE_SEL	XX
0x0103	SW_RESET	XX
0x0104	corrupted frame status	XX
0x0105	mask_corrupted_frames	XX
0x0106	fast standby enable	XX
0x0110	CSI_CH_ID	XX
0x0111	CSI_SIG_MODE	00
0x0114	CSI_LANE_MODE	XX
0x0140	Temperature_EN, Temperature_VAL	XX
0x0142	READOUT_V_CNT [15:8]	XX

Frame Bank B mode

Addr (Hex)	Register Name	in Byte (Hex)
<i>Line1 (Embedded Data Line)</i>		
0x0000	MODEL_ID[15:8]	X2
0x0001	MODEL_ID[7:0]	19
0x0002	FABRICATION_TOP	XX
0x0004	LOT_ID_TOP[23:16]	XX
0x0005	LOT_ID_TOP[15:8]	XX
0x0006	LOT_ID_TOP[7:0]	XX
0x0007	WAFER_NUM_TOP	XX
0x000D	CHIP_NUMBER[15:8]	XX
0x000E	CHIP_NUMBER[7:0]	XX
0x000F	PROCESS_VERSION	XX
0x0011	ROM_ID	XX
0x0018	FRM_CNT[7:0]	XX
0x0019	PX_ORDER	XX
0x001A	DT_PEDESTAL[9:8]	XX
0x001B	DT_PEDESTAL[7:0]	XX
0x0040	FRM_FMT_TYPE[7:0]	XX
0x0041	FRM_FMT_SUBTYPE[7:0]	12
0x0042	FRM_FMT_DESC0[15:8]	XX
0x0043	FRM_FMT_DESC0[7:0]	XX
0x0044	FRM_FMT_DESC1[15:8]	XX
0x0045	FRM_FMT_DESC1[7:0]	XX
0x0046	FRM_FMT_DESC2[15:8]	XX
0x0047	FRM_FMT_DESC2[7:0]	XX
0x0100	MODE_SEL	XX
0x0103	SW_RESET	XX
0x0104	corrupted frame status	XX
0x0105	mask_corrupted_frames	XX
0x0106	fast standby enable	XX
0x0110	CSI_CH_ID	XX
0x0111	CSI_SIG_MODE	00
0x0114	CSI_LANE_MODE	XX
0x0140	Temperature_EN, Temperature_VAL	XX
0x0142	READOUT_V_CNT [15:8]	XX

Addr (Hex)	Register Name	in Byte (Hex)
0x0143	READOUT_V_CNT[7:0]	XX
0x0150	[0]: FRAME_BANK_ENABLE	XX
0x0151	FRAME_BANK_FRM_CNT	XX
0x0152	FRAME_BANK_FAST_TRACKING	XX
<i>Line2 (Embedded Data Line)</i>		
0x0154	FRAME_DURATION_A	XX
0x0155	COMP_ENABLE_A	XX
0x0157	ANA_GAIN_GLOBAL_A	XX
0x0158	DIG_GAIN_GLOBAL_A [11:8]	XX
0x0159	DIG_GAIN_GLOBAL_A [7:0]	XX
0x015A	COARSE_INTEGRATION_TIME_A[15:8]	XX
0x015B	COARSE_INTEGRATION_TIME_A[7:0]	XX
0x015D	SENSOR_MODE_A	XX
0x0160	FRM_LENGTH_A[15:8]	XX
0x0161	FRM_LENGTH_A[7:0]	XX
0x0162	LINE_LENGTH_A[15:8]	XX
0x0163	LINE_LENGTH_A[7:0]	XX
0x0164	X_ADD_STA_A[11:8]	XX
0x0165	X_ADD_STA_A[7:0]	XX
0x0166	X_ADD_END_A[11:8]	XX
0x0167	X_ADD_END_A[7:0]	XX
0x0168	Y_ADD_STA_A[11:8]	XX
0x0169	Y_ADD_STA_A[7:0]	XX
0x016A	Y_ADD_END_A[11:8]	XX
0x016B	Y_ADD_END_A[7:0]	XX
0x016C	x_output_size[11:8]	XX
0x016D	x_output_size[7:0]	XX
0x016E	y_output_size[11:8]	XX
0x016F	y_output_size[7:0]	XX
0x0170	X_ODD_INC_A	XX
0x0171	Y_ODD_INC_A	XX
0x0172	IMG_ORIENTATION_A	XX
0x0174	BINNING_MODE_H_A	XX
0x0175	BINNING_MODE_V_A	XX
0x0176	BINNING_CAL_MODE_H_A	XX

Addr (Hex)	Register Name	in Byte (Hex)
0x0143	READOUT_V_CNT[7:0]	XX
0x0150	[0]: FRAME_BANK_ENABLE	XX
0x0151	FRAME_BANK_FRM_CNT	XX
0x0152	FRAME_BANK_FAST_TRACKING	XX
<i>Line2 (Embedded Data Line)</i>		
0x0254	FRAME_DURATION_B	XX
0x0255	COMP_ENABLE_B	XX
0x0257	ANA_GAIN_GLOBAL_B	XX
0x0258	DIG_GAIN_GLOBAL_B[11:8]	XX
0x0259	DIG_GAIN_GLOBAL_B[7:0]	XX
0x025A	COARSE_INTEGRATION_TIME_B[15:8]	XX
0x025B	COARSE_INTEGRATION_TIME_B[7:0]	XX
0x025D	SENSOR_MODE_B	XX
0x0260	FRM_LENGTH_B[15:8]	XX
0x0261	FRM_LENGTH_B[7:0]	XX
0x0262	LINE_LENGTH_B[15:8]	XX
0x0263	LINE_LENGTH_B[7:0]	XX
0x0264	X_ADD_STA_B[11:8]	XX
0x0265	X_ADD_STA_B[7:0]	XX
0x0266	X_ADD_END_B[11:8]	XX
0x0267	X_ADD_END_B[7:0]	XX
0x0268	Y_ADD_STA_B[11:8]	XX
0x0269	Y_ADD_STA_B[7:0]	XX
0x026A	Y_ADD_END_B[11:8]	XX
0x026B	Y_ADD_END_B[7:0]	XX
0x026C	x_output_size[11:8]	XX
0x026D	x_output_size[7:0]	XX
0x026E	y_output_size[11:8]	XX
0x026F	y_output_size[7:0]	XX
0x0270	X_ODD_INC_B	XX
0x0271	Y_ODD_INC_B	XX
0x0272	IMG_ORIENTATION_B	XX
0x0274	BINNING_MODE_H_B	XX
0x0275	BINNING_MODE_V_B	XX
0x0276	BINNING_CAL_MODE_H_B	XX

Addr (Hex)	Register Name	in Byte (Hex)
0x0177	BINNING_CAL_MODE_V_A	XX
0x0188	RESERVE	XX
0x0189	ANA_GAIN_GLOBAL_SHORT_A	XX
0x018A	COARSE_INTEG_TIME_SHORT_A[15:8]	XX
0x018B	COARSE_INTEG_TIME_SHORT_A[7:0]	XX
0x018C	CSI_DATA_FORMAT_A [15:8]	XX
0x018D	CSI_DATA_FORMAT_A [7:0]	XX
0x0190	LSC_ENABLE_A	XX
0x0191	LSC_COLOR_MODE_A	XX
0x0192	LSC_SELECT_TABLE_A	XX
0x0193	LSC_TUNING_ENABLE_A	XX
0x0194	LSC_WHITE_BALANCE_RG_A[15:8]	XX
0x0195	LSC_WHITE_BALANCE_RG_A[7:0]	XX
0x0196	RESERVE	XX
0x0197	RESERVE	XX
0x0198	LSC_TUNING_COEF_R_A	XX
0x0199	LSC_TUNING_COEF_GR_A	XX
0x019A	LSC_TUNING_COEF_GB_A	XX
0x019B	LSC_TUNING_COEF_B_A	XX
0x019C	LSC_TUNING_R_A[12:8]	XX
0x019D	LSC_TUNING_R_A[7:0]	XX
0x019E	LSC_TUNING_GR_A[12:8]	XX
0x019F	LSC_TUNING_GR_A[7:0]	XX
0x01A0	LSC_TUNING_GB_A[12:8]	XX
0x01A1	LSC_TUNING_GB_A[7:0]	XX
0x01A2	LSC_TUNING_B_A[12:8]	XX
0x01A3	LSC_TUNING_B_A[7:0]	XX
0x01A4	LSC_KNOT_POINT_FORMAT_A	XX
0x0301	VTPXCK_DIV	XX
0x0303	VTSYCK_DIV	XX
0x0304	PREPLLCK_VT_DIV	XX
0x0305	PREPLLCK_OP_DIV	XX
0x0306	PLL_VT_MPY[10:8]	XX
0x0307	PLL_VT_MPY[7:0]	XX
0x0309	OPPXCK_DIV	XX

Addr (Hex)	Register Name	in Byte (Hex)
0x0277	BINNING_CAL_MODE_V_B	XX
0x0288	RESERVE	XX
0x0289	ANA_GAIN_GLOBAL_SHORT_B	XX
0x028A	COARSE_INTEG_TIME_SHORT_B [15:8]	XX
0x028B	COARSE_INTEG_TIME_SHORT_B [7:0]	XX
0x028C	CSI_DATA_FORMAT_B [15:8]	XX
0x028D	CSI_DATA_FORMAT_B [7:0]	XX
0x0290	LSC_ENABLE_B	XX
0x0291	LSC_COLOR_MODE_B	XX
0x0292	LSC_SELECT_TABLE_B	XX
0x0293	LSC_TUNING_ENABLE_B	XX
0x0294	LSC_WHITE_BALANCE_RG_B[15:8]	XX
0x0295	LSC_WHITE_BALANCE_RG_B[7:0]	XX
0x0296	RESERVE	XX
0x0297	RESERVE	XX
0x0298	LSC_TUNING_COEF_R_B	XX
0x0299	LSC_TUNING_COEF_GR_B	XX
0x029A	LSC_TUNING_COEF_GB_B	XX
0x029B	LSC_TUNING_COEF_B_B	XX
0x029C	LSC_TUNING_R_B[12:8]	XX
0x029D	LSC_TUNING_R_B[7:0]	XX
0x029E	LSC_TUNING_GR_B[12:8]	XX
0x029F	LSC_TUNING_GR_B[7:0]	XX
0x02A0	LSC_TUNING_GB_B[12:8]	XX
0x02A1	LSC_TUNING_GB_B[7:0]	XX
0x02A2	LSC_TUNING_B_B[12:8]	XX
0x02A3	LSC_TUNING_B_B[7:0]	XX
0x02A4	LSC_KNOT_POINT_FORMAT_B	XX
0x0301	VTPXCK_DIV	XX
0x0303	VTSYCK_DIV	XX
0x0304	PREPLLCK_VT_DIV	XX
0x0305	PREPLLCK_OP_DIV	XX
0x0306	PLL_VT_MPY[10:8]	XX
0x0307	PLL_VT_MPY[7:0]	XX
0x0309	OPPXCK_DIV	XX

Addr (Hex)	Register Name	in Byte (Hex)
0x030B	OPSYCK_DIV	XX
0x030C	PLL_OP_MPY[10:8]	XX
0x030D	PLL_OP_MPY[7:0]	XX
0x030E	RESERVE	XX
0x0318	RESERVE	XX
0x0319	RESERVE	XX
0x031A	RESERVE	XX
0x031B	RESERVE	XX
0x031C	RESERVE	XX
0x031D	RESERVE	XX
0x031E	RESERVE	XX
0x031F	RESERVE	XX
0x0321	FLASH_STATUS	XX

Addr (Hex)	Register Name	in Byte (Hex)
0x030B	OPSYCK_DIV	XX
0x030C	PLL_OP_MPY[10:8]	XX
0x030D	PLL_OP_MPY[7:0]	XX
0x030E	RESERVE	XX
0x0318	RESERVE	XX
0x0319	RESERVE	XX
0x031A	RESERVE	XX
0x031B	RESERVE	XX
0x031C	RESERVE	XX
0x031D	RESERVE	XX
0x031E	RESERVE	XX
0x031F	RESERVE	XX
0x0321	FLASH_STATUS	XX

CONFIDENTIAL

4. Output Data Format

4-1 CSI-2 Output Data Format

4-1-1 CSI-2 Output Data Channels

The IMX219PQH5-C can select the CSI-2 2 lanes or CSI-2 4 lanes serial signal output method that uses all pairs of differential signals for image data output.

Table 12 Number of CSI lane Setting Registers

Index	Byte	Register Name	RW	Comment	Default (HEX)	Remark
0x0114	[1:0]	CSI_LANE_MODE	RW	03: 4Lane 01: 2Lane	03	Setting before "standby cancel"

4-1-2 CSI-2 Frame Structure

The image frame structure is shown below.

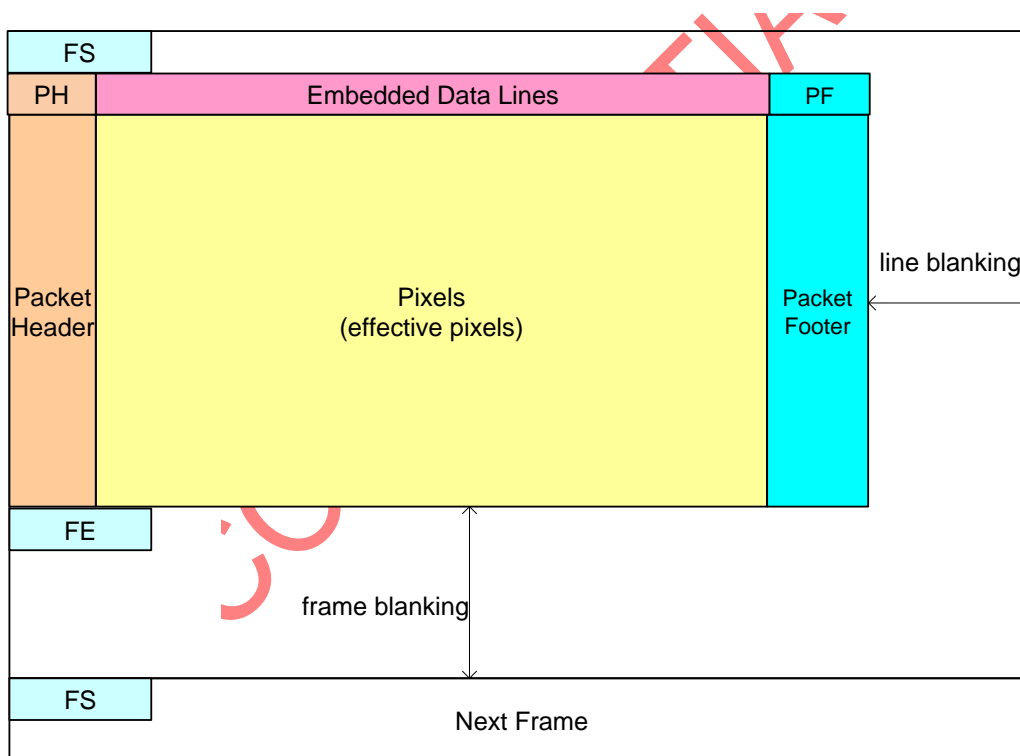

Fig. 20 Frame Structure for Serial signal output

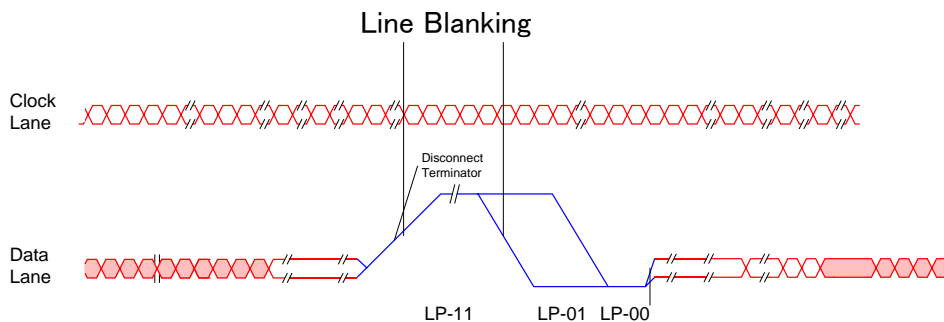

Fig. 21 Signaling Waveform during Line Blanking Period (CSI-2)

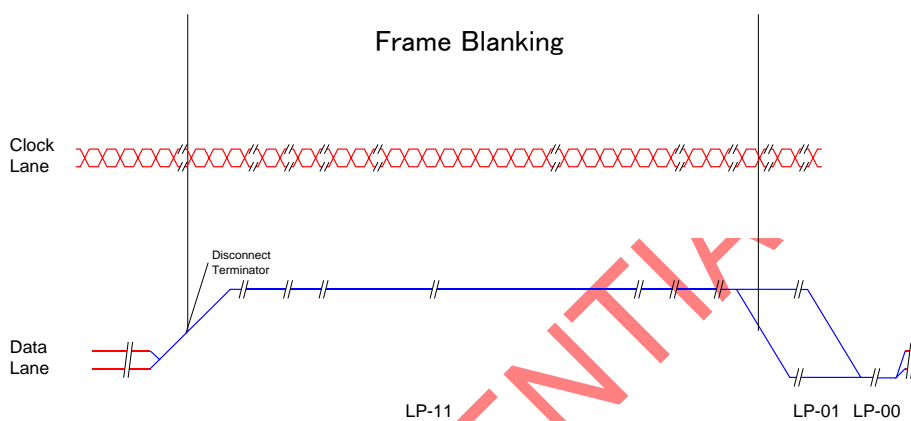

Fig. 22 Signaling Waveform during Frame Blanking Period (CSI-2)

4-1-3 Short Packet & Long Packet

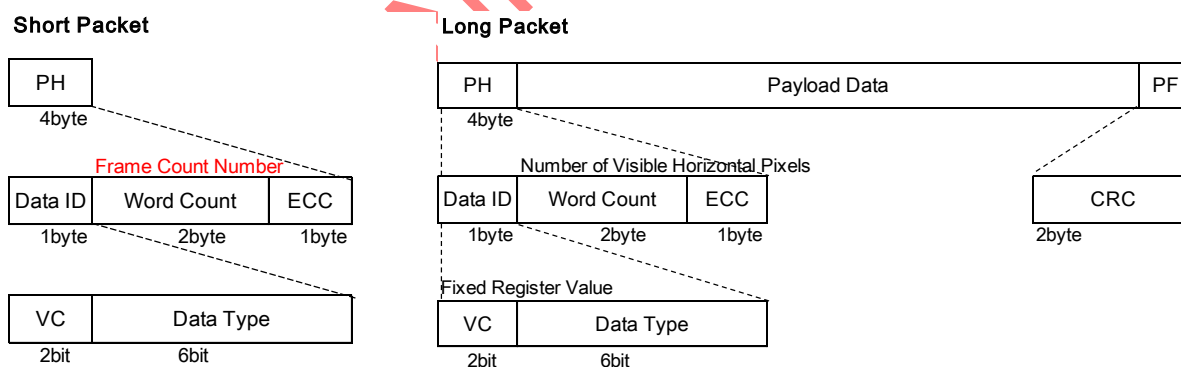

Fig. 23 Short Packet & Long Packet

4-1-4 Data type

Data types of each line are shown as below.

Table 13 Image pixel area and data type

image pixel area	Data Type
Embedded Data Lines	Embedded Data
OBSide ineffective area	Null
OB area for internal use	Null
effective OB	OPB Data
Effective area side ineffective area	Null
effective pixel	RAW10 or RAW8 or COMP8

4-1-5 CSI-2 Frame Format

The data format of each line is based on CSI-2 General Frame Format.

The period from a line end sync code to the line start sync code for the next line is called the line blanking period. Likewise, the period from a frame end sync code to the next frame start sync code is called the frame blanking period. Packet header consists of the following data.

Table 14 Sync Code Settings

Header [7:0]	Description	Setting register	Remarks
[7:6]	Virtual Channel Identifier	Addr: 0x0110 CSI_channel_identifier	See Register Section
[5:0]	Synch Short Packet Data types	NA	
6'h00	Frame Start Code	NA	
6'h01	Frame End Code	NA	
6'h12	Embedded Data	NA	Written data in the sensor
6'h2A	RAW8	CSI_data_format	16'h0808
6'h2B	RAW10	CSI_data_format	16'h0A0A

4-1-6 CSI-2 Embedded Data Line

The value of the 2-wire serial communication configuration register can be output at the start of the frame. The output register is indicated in the “Embd DL” column of the 2-wire serial communication Register Map. The Embedded data line is output in the two lines following the sync code FS.

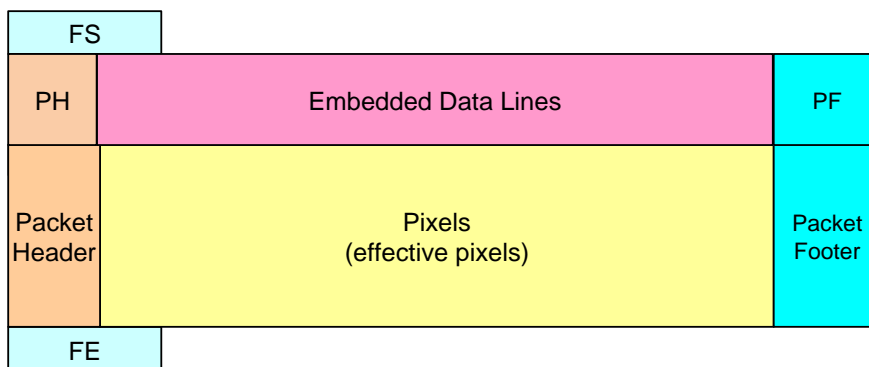

Fig. 24 Frame Format during Embedded Data Line Output

The output method differs according to the data format. In RAW10 mode, dummy bytes are inserted after outputting 4 bytes of data and tags.

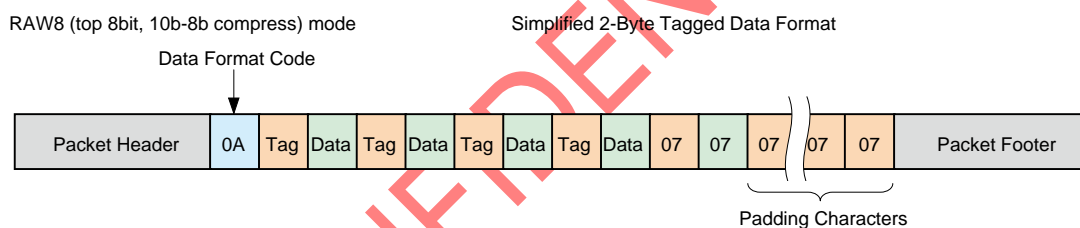

Fig. 25 Embedded data lines alignment in RAW8 mode

RAW10 mode Simplified 2-Byte Tagged Data Format

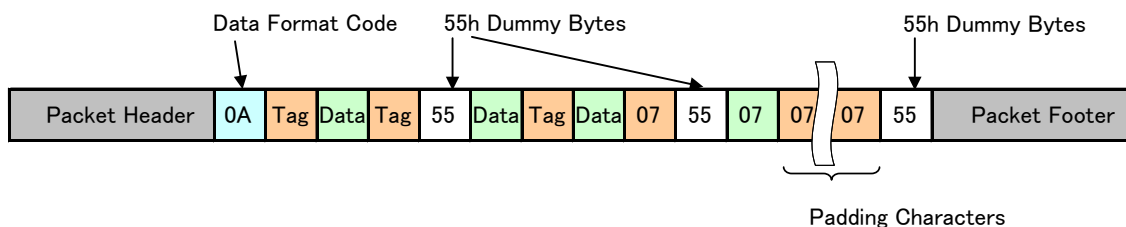

Fig. 26 Detailed Embedded Data Line Output in RAW10 Output Mode

The end of the address and register value is determined according to the tags embedded in the data.

Table 15 Embedded Data Line Tag

Tag	Data Byte Description
00h	Illegal Tag. If found treat as end of Data
07h	End of Data (Data Byte Value = 07H)
aah	CCI Register Index MSB [15:8]
a5h	CCI Register Index LSB [7:0]
5ah	Auto increment the CCI index after the data byte - valid data Data byte contains valid CCI register data
55h	Auto increment the CCI index after the data byte - null data A CCI register does NOT exist for the current CCI index. The data byte value is the 07H
ffh	Illegal Tag. If found treat as end of Data

CONFIDENTIAL

5. Setting Required for Imaging

5-1 Pixel Array Physical Image

Pixel array physical image is shown below. It is the pixel array when upper right corner of the physical image is Pin 1. The IMX219PQH5-C has vertical OB area, which cannot read out. Readout position is explained by Readout Position session

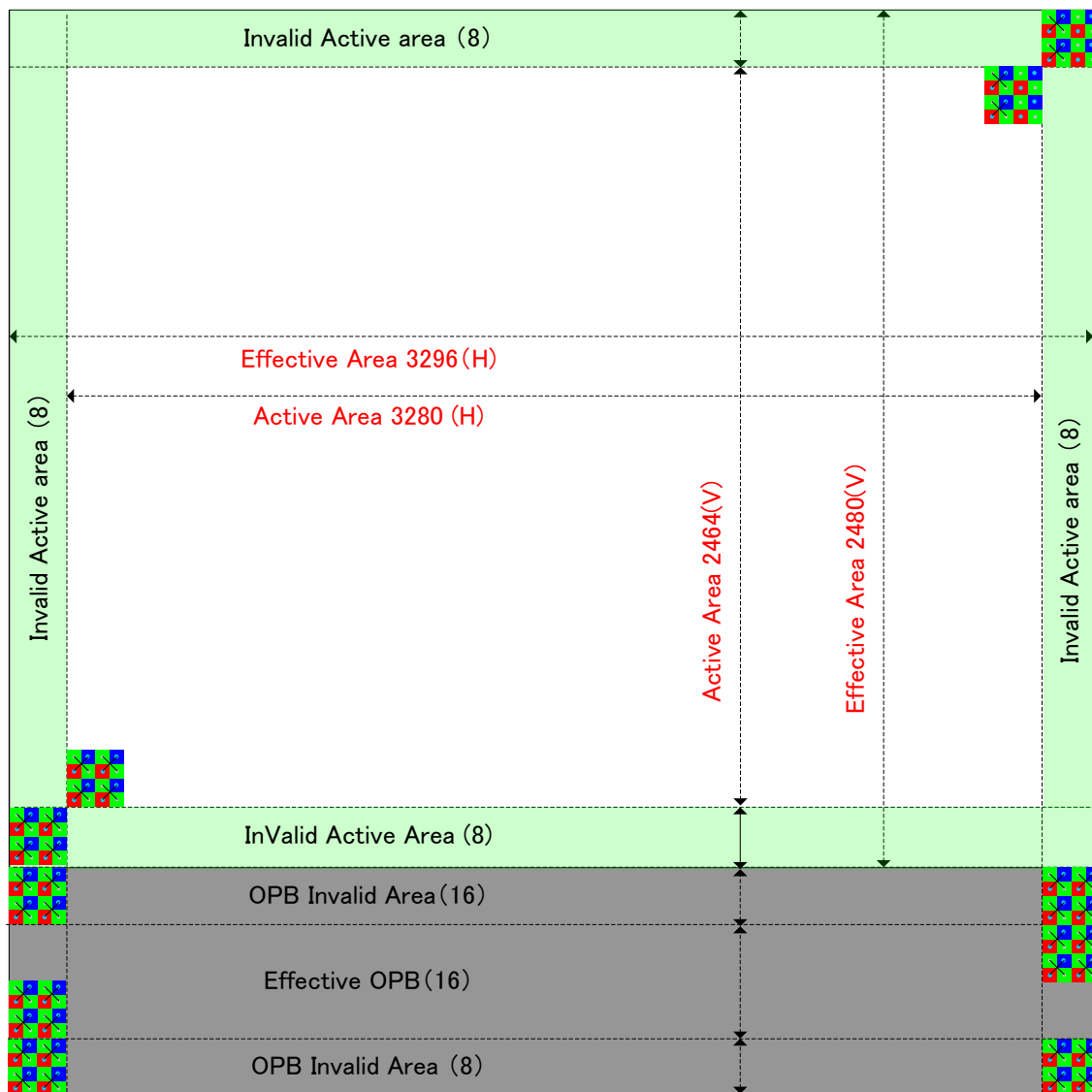

Fig. 27 Pixel Array Physical Image

5-2 Pixel Binning Mode

Binning read-out can be used to obtain an image of lower resolution for full field of view. It has advantage on frame rate than using digital scaling, and on signal-to-noise ratio than using sub-sampling. See Binning Capability Registers, for detail of available configurations.

The following diagram describes on 2x2 averaged binning operations. Pixels of two adjacent rows and columns are averaged, and read out as one output pixel.

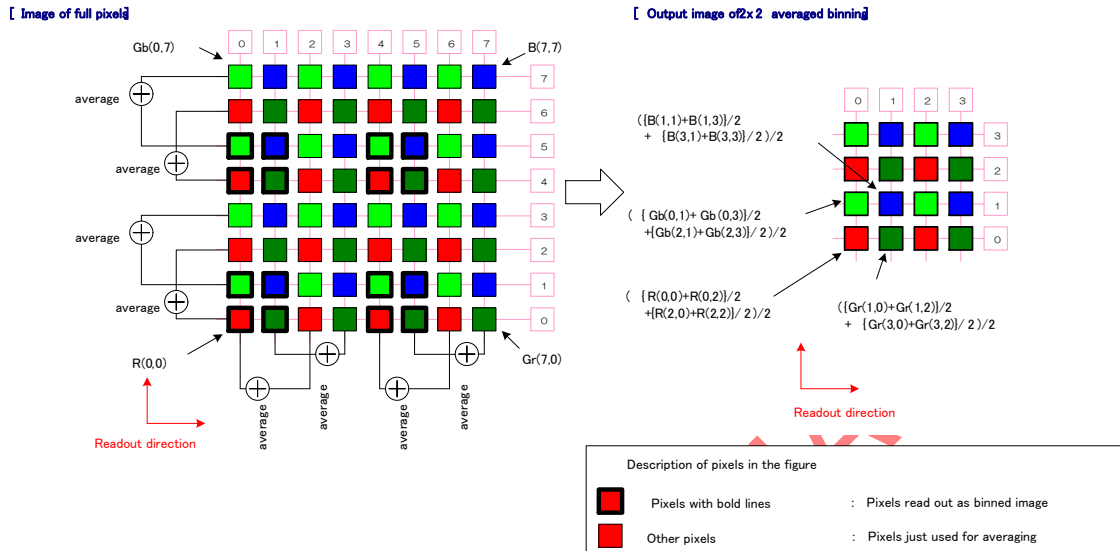

Fig. 28 Image of 2x2 averaged Binning Mode

For explanation, represent individual pixels with its addresses in the format "color (x, y)" - for example, The Red pixel in the lower left corner is expressed as R (0, 0). By performing 2x2 binning, R (0, 0) after binning is obtained by the following equation.

$$R(0, 0) \text{ after binning} = \frac{([R(0, 0) + R(0, 2)]/2 + [R(2, 0) + R(2, 2)]/2)/2}{2}$$

And, the total number of output pixels is reduced to 1/4 of the original pixel array.

Settings mode example

Table 16 Mode example

Mode	Full	x2binning	x4binning
Frame rate	30 frame/s	120 frame/s	120 frame/s
H binning	—	Analog	Digital
H	x1	x2	X4
V	x1	x2	x4

5-3 image size

The relation of image output size and the register is shown below.

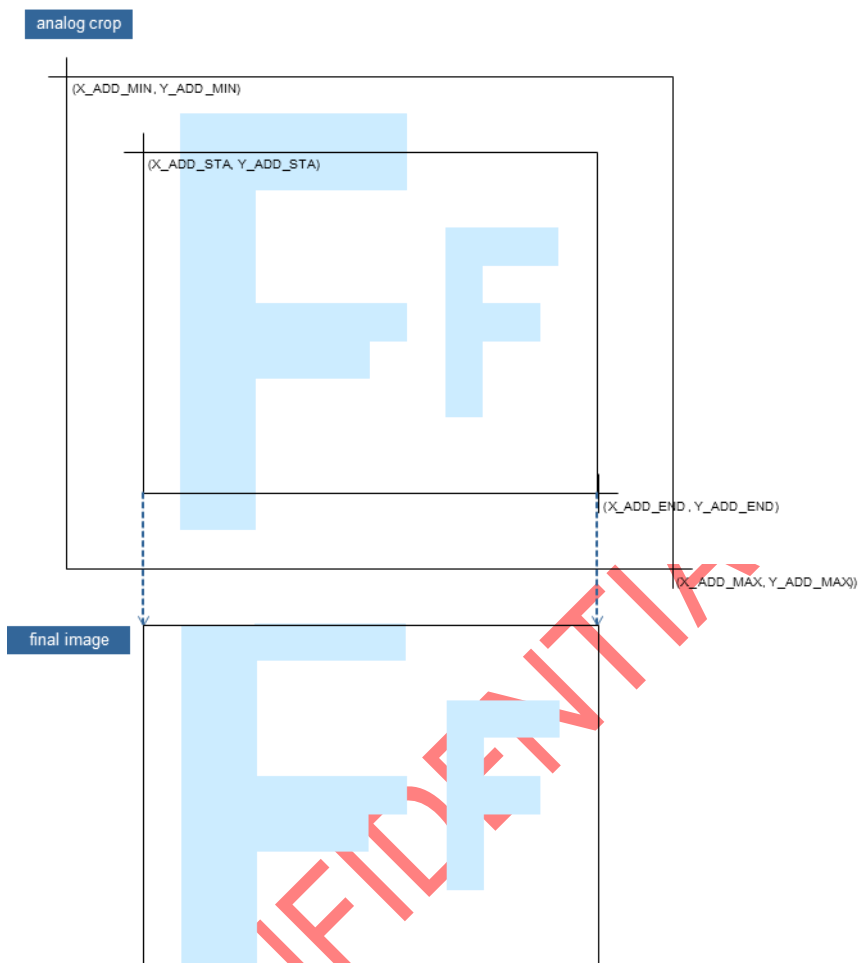

Fig. 29 Image size

5-4 Readout Position

The IMX219PQH5-C default status is readout from the lower left corner when Pin 1 is located in the upper right corner. The image is inverted vertically and horizontally by the lens, so proper image output results when Pin 1 is located in the upper right corner.

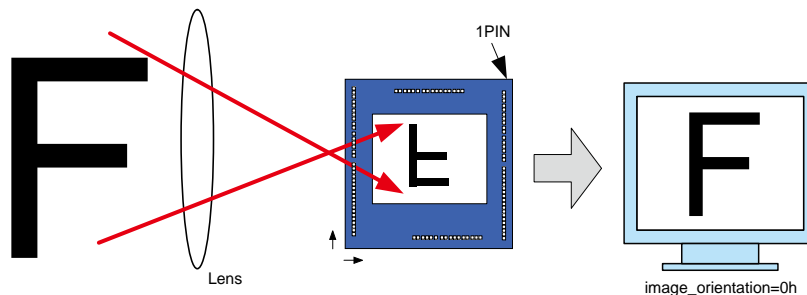

Fig. 30 Readout Position

Readout direction can be set by the registers.

Table 17 Image Orientation Register

CCI register	image_orientation [0]	Mode
	0	no mirror (Readout from the left with Pin 1 in the upper right corner)
	1	Horizontal Mirror (Readout from the right with Pin 1 in the upper right corner)
	image_orientation [1]	Mode
	0	no flip (Readout from the bottom with Pin 1 in the upper right corner)
	1	Vertical Flip (Readout from the top with Pin 1 in the upper right corner)

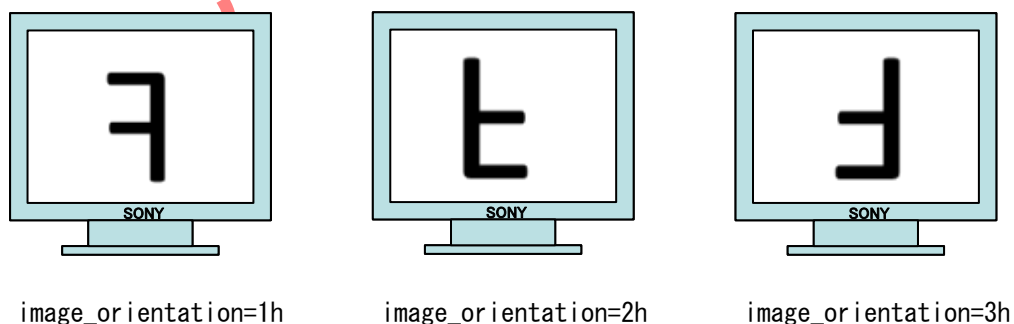

Fig. 31 Output Image Diagrams for Vertical Flip and Horizontal Mirror

5-5 Frame Rate Calculation Formula

Frame rate in all-pixel scan mode is calculated by the followings.

$$\text{Frame_Rate[frame/s]} = \frac{1}{\text{Time_per_Line[sec]} \times (\text{Frame_Length})}$$

$$\text{Time_Per_Line_}[sec] = \frac{\text{Line_Length_pck[pix]}}{2 \times \text{Pix_Clock_Freq[MHz]}}$$

- [In the case of (frame_length_lines - 4 > coarse_integration_time)]: Frame_Length = frame_length_lines
- [In the case of (frame_length_lines - 4 < coarse_integration_time)]: Frame_Length = coarse_integration_time + 4

5-6 Black Level Control

The IMX219PQH5-C has a stable black level clamp function. The average value of the black level is adjusted to 64d. When selecting output format RAW8, Black level in the table below is divided by 4.

Table 18 Gain Setting Variables

CCI	Black Level (dec)
	64 (Fixed) RAW10, COMP8
	16 (Fixed) RAW8

5-7 Storage Time (Electronic Shutter) Settings

5-7-1 Storage Time (Electronic Shutter) Setting Registers

The storage time setting registers are shown below. The value of the register, coarse_integration_time, indicates the number of lines for the storage time.
 The maximum storage time value in normal frame rate mode is obtained by subtracting “4” from the number of lines per frame (set by frame_length_lines) including the blanking period.

Table 19 Storage Time Setting Register

CCI registers	Register name	Address	Setting value (dec)	Remarks
	coarse_integration_time	0x015A 0x015B 0x025A 0x025B	1 to frame_length_lines-4	0x015A = coarse_integration_time_A[15:8] 0x015B = coarse_integration_time_A[7:0] 0x025A = coarse_integration_time_B[15:8] 0x025B = coarse_integration_time_B[7:0]

The value of the register, fine_integration_time, indicates the number of pixels for the storage time.
 The register, fine_integration_time, is a fixed value, read only register.

Table 20 Storage Time Offset Register

CCI registers	Register name	Address	Setting value (dec)	Remarks
	fine_integration_time	0x0388 0x0389	500	RO register

5-7-2 Storage Time Calculation Method

The storage time (T_{SH}) can be obtained from the following equation.

$$T_{SH} = (\text{Coarse_Integration_Time} \times \text{Time_Per_Line}) + (\alpha \times \text{pix_clk_period})$$

$$\text{pix_clk_period} = 1/\text{Pix_Clock_Freq [MHz]}$$

Where α = offset time = readdable from fine_integration_time register and obtained from the following equation.
 $\alpha = \text{fine_integration_time} / 2$

Table 21 Storage Time Setting (in case of Line_Length_pck = 3448)

	Number of total lines	frame_length	coarse_integration_time [15:0]	Storage time (T_{SH})
	Dec	Dec	Dec	All-pixel scan[s]
Normal frame rate mode (4:3 Full-Pel Raw10)	2728	2728 (determined by frame_length_lines [15:0])	1	$(1 \times 3448/2 + \alpha) \times \text{pix_clk_period}$
			N	$(N \times 3448/2 + \alpha) \times \text{pix_clk_period}$
			:	:
			2724	$(2724 \times 3448/2 + \alpha) \times \text{pix_clk_period}$
Low frame rate mode Long-time exposure	2729	2729	2725	$(2725 \times 3448/2 + \alpha) \times \text{pix_clk_period}$
	2730	2730	2726	$(2726 \times 3448/2 + \alpha) \times \text{pix_clk_period}$
	:	:	:	:
	2M+3	2M+3	2M-1	$((2M-1) \times 3448/2 + \alpha) \times \text{pix_clk_period}$
	2M+4	2M+4	2M	$(2M \times 3448/2 + \alpha) \times \text{pix_clk_period}$
	:	:	:	:
	65534	65534	65530	$(65530 \times 3448/2 + \alpha) \times \text{pix_clk_period}$

5-8 Gain Settings

Analogue gain and digital gain can be set independently.

5-8-1 Analogue Gain Settings

Only global analogue gain is supported.

The analogue gain is set by the following equation.

$$\text{Gain_analogue} = \frac{(m0 \times X + c0)}{(m1 \times X + c1)}$$

The variables are shown in the table below.

Table 22 Gain Setting Variables

	Register name	Address	Remarks	
CCI registers	m0	analogue_gain_m0	0x008C/0x008D	Fixed to 0
	m1	analogue_gain_m1	0x0090/0x0091	Fixed to -1
	c0	analogue_gain_c0	0x008E/0x008F	Fixed to 256
	c1	analogue_gain_c1	0x0092/0x0093	Fixed to 256
	X	ANA_GAIN_GLOBAL_A	0x0157,	0 to 232
	X	ANA_GAIN_GLOBAL_B	0x0257	0 to 232

Therefore, the analogue gain is as follows.

$$\text{Gain_analogue} = \frac{(256)}{(256 - X)}$$

The relationship between the setting value X (analogue_gain_code_global) and the gain is shown on the following page.

CONFIDENTIAL

Table 23 Analogue Gain Setting

ANA_GAIN_GLOBAL	Gain(times)	Gain(dB)	ANA_GAIN_GLOBAL	Gain(times)	Gain(dB)	ANA_GAIN_GLOBAL	Gain(times)	Gain(dB)	ANA_GAIN_GLOBAL	Gain(times)	Gain(dB)
0	1.00	0.00	64	1.33	2.50	128	2.00	6.02	192	4.00	12.04
1	1.00	0.03	65	1.34	2.54	129	2.02	6.09	193	4.06	12.18
2	1.01	0.07	66	1.34	2.59	130	2.03	6.16	194	4.13	12.32
3	1.01	0.10	67	1.35	2.64	131	2.05	6.23	195	4.20	12.46
4	1.02	0.14	68	1.36	2.68	132	2.06	6.30	196	4.27	12.60
5	1.02	0.17	69	1.37	2.73	133	2.08	6.37	197	4.34	12.75
6	1.02	0.21	70	1.38	2.77	134	2.10	6.44	198	4.41	12.90
7	1.03	0.24	71	1.38	2.82	135	2.11	6.51	199	4.49	13.05
8	1.03	0.28	72	1.39	2.87	136	2.13	6.58	200	4.57	13.20
9	1.04	0.31	73	1.40	2.92	137	2.15	6.65	201	4.65	13.36
10	1.04	0.35	74	1.41	2.96	138	2.17	6.73	202	4.74	13.52
11	1.04	0.38	75	1.41	3.01	139	2.19	6.80	203	4.83	13.68
12	1.05	0.42	76	1.42	3.06	140	2.20	6.88	204	4.92	13.84
13	1.05	0.45	77	1.43	3.11	141	2.22	6.95	205	5.02	14.01
14	1.05	0.49	78	1.44	3.16	142	2.24	7.03	206	5.12	14.19
15	1.06	0.52	79	1.45	3.21	143	2.26	7.10	207	5.22	14.36
16	1.07	0.56	80	1.45	3.25	144	2.29	7.18	208	5.33	14.54
17	1.07	0.60	81	1.46	3.30	145	2.30	7.26	209	5.45	14.72
18	1.07	0.63	82	1.47	3.35	146	2.32	7.34	210	5.56	14.91
19	1.08	0.67	83	1.48	3.40	147	2.35	7.42	211	5.69	15.10
20	1.08	0.71	84	1.49	3.45	148	2.37	7.50	212	5.82	15.30
21	1.09	0.74	85	1.50	3.50	149	2.39	7.58	213	5.95	15.50
22	1.09	0.78	86	1.50	3.56	150	2.41	7.66	214	6.09	15.70
23	1.10	0.82	87	1.51	3.61	151	2.44	7.74	215	6.24	15.91
24	1.10	0.86	88	1.52	3.66	152	2.46	7.82	216	6.40	16.12
25	1.11	0.89	89	1.53	3.71	153	2.48	7.91	217	6.56	16.34
26	1.11	0.93	90	1.54	3.76	154	2.51	7.99	218	6.73	16.57
27	1.12	0.97	91	1.55	3.82	155	2.53	8.08	219	6.92	16.80
28	1.12	1.01	92	1.56	3.87	156	2.56	8.16	220	7.11	17.04
29	1.13	1.04	93	1.57	3.92	157	2.58	8.25	221	7.31	17.28
30	1.13	1.08	94	1.58	3.97	158	2.61	8.34	222	7.53	17.54
31	1.14	1.12	95	1.59	4.03	159	2.64	8.43	223	7.75	17.79
32	1.14	1.16	96	1.60	4.08	160	2.66	8.52	224	8.00	18.06
33	1.14	1.20	97	1.61	4.14	161	2.69	8.61	225	8.26	18.34
34	1.15	1.24	98	1.62	4.19	162	2.72	8.70	226	8.53	18.62
35	1.16	1.28	99	1.63	4.25	163	2.75	8.80	227	8.82	18.92
36	1.16	1.32	100	1.64	4.30	164	2.78	8.89	228	9.14	19.22
37	1.17	1.36	101	1.65	4.36	165	2.81	8.98	229	9.48	19.54
38	1.17	1.40	102	1.66	4.41	166	2.84	9.08	230	9.84	19.87
39	1.18	1.44	103	1.67	4.47	167	2.88	9.18	231	10.24	20.21
40	1.18	1.48	104	1.68	4.53	168	2.91	9.28	232	10.66	20.56
41	1.19	1.52	105	1.70	4.59	169	2.94	9.37			
42	1.20	1.56	106	1.70	4.64	170	2.98	9.47			
43	1.20	1.60	107	1.71	4.70	171	3.01	9.58			
44	1.21	1.64	108	1.73	4.76	172	3.05	9.68			
45	1.21	1.68	109	1.74	4.82	173	3.08	9.78			
46	1.22	1.72	110	1.75	4.88	174	3.12	9.89			
47	1.22	1.76	111	1.76	4.94	175	3.16	10.00			
48	1.23	1.80	112	1.78	5.00	176	3.20	10.10			
49	1.23	1.85	113	1.79	5.06	177	3.24	10.21			
50	1.24	1.89	114	1.80	5.12	178	3.28	10.32			
51	1.25	1.93	115	1.81	5.18	179	3.32	10.43			
52	1.25	1.97	116	1.83	5.24	180	3.37	10.55			
53	1.26	2.01	117	1.84	5.30	181	3.41	10.66			
54	1.27	2.06	118	1.85	5.37	182	3.46	10.78			
55	1.27	2.10	119	1.87	5.43	183	3.50	10.90			
56	1.28	2.14	120	1.88	5.49	184	3.55	11.02			
57	1.29	2.19	121	1.89	5.56	185	3.61	11.14			
58	1.29	2.23	122	1.91	5.62	186	3.66	11.26			
59	1.30	2.28	123	1.92	5.69	187	3.71	11.39			
60	1.30	2.32	124	1.94	5.75	188	3.76	11.51			
61	1.31	2.36	125	1.95	5.82	189	3.82	11.64			
62	1.32	2.41	126	1.97	5.89	190	3.88	11.77			
63	1.32	2.45	127	1.98	5.95	191	3.94	11.91			

5-8-2 Digital gain settings

The IMX219PQH5-C can set the digital gain for global. The registers required to set the digital gain are as follows.

Table 24 Digital Gain Settings

CCI register name	Upper byte address (Setting range:1 to15)	Lower byte address (Setting range:0 to 255)
DIG_GAIN_GLOBAL_A	0x0158	0x0159
DIG_GAIN_GLOBAL_B	0x0258	0x0259

Each register is comprised of 2 bytes, with the upper byte [15:8] setting the integer portion and the lower byte [7:0] setting the fractional portion of the gain. The gain for global is obtained by the following equation.

$$\text{Gain_digital} = \text{Upperbyte} + \frac{\text{Lowerbyte}}{256}$$

The upper byte can be set to a value between 1 and 15, and the lower byte to a value between 0 and 255. Therefore, the digital gain setting range for global is as follows.

$$1 + \frac{0}{256} [\text{times}] (0 \text{ dB}) \leq \text{Gain_digital} \leq 15 + \frac{255}{256} [\text{times}] (24 \text{ dB})$$

When gain is considered in log linear scale, the adjustment steps are large at low gain and extremely small at high gain. The register values are shown on the following page in case of the gain in log linear manner in 0.1 dB steps.

CONFIDENTIAL

Table 25 Example of Digital Gain Setting

Upper byte		Lower byte		Gain(times)	Gain(dB)
dec	hex	dec	hex		
1	1	0	0	1.00	0.00
1	1	3	3	1.01	0.10
1	1	6	6	1.02	0.20
1	1	9	9	1.04	0.30
1	1	12	C	1.05	0.40
1	1	15	F	1.06	0.49
1	1	18	12	1.07	0.59
1	1	21	15	1.08	0.68
1	1	25	19	1.10	0.81
1	1	28	1C	1.11	0.90
1	1	31	1F	1.12	0.99
1	1	35	23	1.14	1.11
1	1	38	26	1.15	1.20
1	1	41	29	1.16	1.29
1	1	45	2D	1.18	1.41
1	1	48	30	1.19	1.49
1	1	52	34	1.20	1.61
1	1	55	37	1.21	1.69
1	1	59	3B	1.23	1.80
1	1	63	3F	1.25	1.91
1	1	66	42	1.26	1.99
1	1	70	46	1.27	2.10
1	1	74	4A	1.29	2.21
1	1	78	4E	1.30	2.31
1	1	81	51	1.32	2.39
1	1	85	55	1.33	2.49
1	1	89	59	1.35	2.59
1	1	93	5D	1.36	2.69
1	1	97	61	1.38	2.79
1	1	101	65	1.39	2.89
1	1	106	6A	1.41	3.01
1	1	110	6E	1.43	3.10
1	1	114	72	1.45	3.20
1	1	118	76	1.46	3.29
1	1	123	7B	1.48	3.41
1	1	127	7F	1.50	3.50
1	1	131	83	1.51	3.59
1	1	136	88	1.53	3.70
1	1	140	8C	1.55	3.79
1	1	145	91	1.57	3.90
1	1	150	96	1.59	4.01
1	1	154	9A	1.60	4.09
1	1	159	9F	1.62	4.20
1	1	164	A4	1.64	4.30
1	1	169	A9	1.66	4.40
1	1	174	AE	1.68	4.50
1	1	179	B3	1.70	4.60
1	1	184	B8	1.72	4.70
1	1	189	BD	1.74	4.80
1	1	194	C2	1.76	4.90
1	1	199	C7	1.78	5.00
1	1	205	CD	1.80	5.11
1	1	210	D2	1.82	5.20
1	1	215	D7	1.84	5.30
1	1	221	DD	1.86	5.41
1	1	226	E2	1.88	5.50
1	1	232	E8	1.91	5.60
1	1	237	ED	1.93	5.69
1	1	243	F3	1.95	5.80
1	1	249	F9	1.97	5.90
2	2	255	FF	2.00	6.00
2	2	5	5	2.02	6.11
2	2	11	B	2.04	6.21
2	2	17	11	2.07	6.30
2	2	23	17	2.09	6.40
2	2	29	1D	2.11	6.50
2	2	35	23	2.14	6.59
2	2	42	2A	2.16	6.71
2	2	48	30	2.19	6.80
2	2	55	37	2.21	6.91
2	2	61	3D	2.24	7.00
2	2	68	44	2.27	7.10
2	2	74	4A	2.29	7.19
2	2	81	51	2.32	7.30
2	2	88	58	2.34	7.40
2	2	95	5F	2.37	7.50
2	2	102	66	2.40	7.60
2	2	109	6D	2.43	7.70
2	2	116	74	2.45	7.79
2	2	124	7C	2.48	7.90
2	2	131	83	2.51	8.00
2	2	138	8A	2.54	8.09
2	2	146	92	2.57	8.20
2	2	154	9A	2.60	8.30
2	2	161	A1	2.63	8.40
2	2	169	A9	2.66	8.50
2	2	177	B1	2.69	8.60
2	2	185	B9	2.72	8.70
2	2	193	C1	2.75	8.80
2	2	201	C9	2.79	8.90
2	2	210	D2	2.82	9.01
2	2	218	DA	2.85	9.10
2	2	226	E2	2.88	9.20
2	2	235	EB	2.92	9.30
2	2	244	F4	2.95	9.41
2	2	252	FC	2.98	9.50
3	3	5	5	3.02	9.60
3	3	14	E	3.05	9.70
3	3	23	17	3.09	9.80
3	3	32	20	3.13	9.90
3	3	42	2A	3.16	10.00
3	3	51	33	3.20	10.10
3	3	60	3C	3.23	10.20
3	3	70	46	3.27	10.30
3	3	80	50	3.31	10.40
3	3	90	5A	3.35	10.50
3	3	99	63	3.39	10.60
3	3	109	6D	3.43	10.70
3	3	120	78	3.47	10.80
3	3	130	82	3.51	10.90
3	3	140	8C	3.55	11.00
3	3	151	97	3.59	11.10
3	3	161	A1	3.63	11.20
3	3	172	AC	3.67	11.30
3	3	183	B7	3.71	11.40
3	3	194	C2	3.76	11.50
3	3	205	CD	3.80	11.60
3	3	217	D9	3.85	11.70
3	3	228	E4	3.89	11.80
3	3	239	EF	3.93	11.90
3	3	251	FB	3.98	12.00
4	4	7	7	4.03	12.10
4	4	19	13	4.07	12.20
4	4	31	1F	4.12	12.30
4	4	43	2B	4.17	12.40
4	4	56	38	4.22	12.50
4	4	68	44	4.27	12.60
4	4	81	51	4.32	12.70
4	4	93	5D	4.36	12.80
4	4	106	6A	4.41	12.90
4	4	120	78	4.47	13.00
4	4	133	85	4.52	13.10
4	4	146	92	4.57	13.20
4	4	160	A0	4.63	13.30
4	4	173	AD	4.68	13.40
4	4	187	BB	4.73	13.50
4	4	201	C9	4.79	13.60
4	4	215	D7	4.84	13.70
4	4	230	E6	4.90	13.80
4	4	244	F4	4.95	13.90
5	5	3	3	5.01	14.00
5	5	18	12	5.07	14.10
5	5	33	21	5.13	14.20
5	5	48	30	5.19	14.30
5	5	64	40	5.25	14.40
5	5	79	4F	5.31	14.50
5	5	95	5F	5.37	14.60
5	5	111	6F	5.43	14.70
5	5	127	7F	5.50	14.80
5	5	143	8F	5.56	14.90
5	5	160	A0	5.63	15.00
5	5	176	B0	5.69	15.10
5	5	193	C1	5.75	15.20
5	5	210	D2	5.82	15.30
5	5	227	E3	5.89	15.40
5	5	245	F5	5.96	15.50
6	6	7	7	6.03	15.60
6	6	24	18	6.09	15.70
6	6	42	2A	6.16	15.80
6	6	61	3D	6.24	15.90
6	6	79	4F	6.31	16.00
6	6	98	62	6.38	16.10
6	6	117	75	6.46	16.20
6	6	136	88	6.53	16.30
6	6	155	9B	6.61	16.40
6	6	175	AF	6.68	16.50
6	6	195	C3	6.76	16.60
6	6	215	D7	6.84	16.70
6	6	235	EB	6.92	16.80
7	7	0	0	7.00	16.90
7	7	20	14	7.08	17.00
7	7	41	29	7.16	17.10
7	7	63	3F	7.25	17.20
7	7	84	54	7.33	17.30
7	7	106	6A	7.41	17.40
7	7	128	80	7.50	17.50
7	7	150	96	7.59	17.60
7	7	172	AC	7.67	17.70
7	7	195	C3	7.76	17.80
7	7	218	DA	7.85	17.90
7	7	241	F1	7.94	18.00
8	8	9	9	8.04	18.10
8	8	33	21	8.13	18.20
8	8	57	39	8.22	18.30
8	8	81	51	8.32	18.40
8	8	106	6A	8.41	18.50
8	8	131	83	8.51	18.60
8	8	156	9C	8.61	18.70
8	8	182	B6	8.71	18.80
8	8	207	CF	8.81	18.90
8	8	234	EA	8.91	19.00
9	9	4	4	9.02	19.10
9	9	31	1F	9.12	19.20
9	9	58	3A	9.23	19.30
9	9	85	55	9.33	19.40
9	9	113	71	9.44	19.50
9	9	141	8D	9.55	19.60
9	9	169	A9	9.66	19.70
9	9	198	C6	9.77	19.80
9	9	227	E3	9.89	19.90
10	A	0	0	10.00	20.00
10	A	30	1E	10.12	20.10
10	A	60	3C	10.23	20.20
10	A	90	5A	10.35	20.30
10	A	121	79	10.47	20.40
10	A	152	98	10.59	20.50
10	A	183	B7	10.71	20.60
10	A	215	D7	10.84	20.70
10	A	247	F7	10.96	20.80
11	B	23	17	11.09	20.90
11	B	56	38	11.22	21.00
11	B	90	5A	11.35	21.10
11	B	123	7B	11.48	21.20
11	B	157	9D	11.61	21.30
11	B	192	C0	11.75	21.40
11	B	227	E3	11.89	21.50
12	C	6	6	12.02	21.60
12	C	41	29	12.16	21.70
12	C	77	4D	12.30	21.80
12	C	114	72	12.45	21.90
12	C	151	97	12.59	22.00
12	C	188	BC	12.73	22.10
12	C	226	E2	12.88	22.20
13	D	8	8	13.03	22.30
13	D	47	2F	13.18	22.40
13	D	86	56	13.34	22.50
13	D	125	7D	13.49	22.60
13	D	165	A5	13.64	22.70
13	D	206	CE	13.80	22.80
13	D	247	F7	13.96	22.90
14	E	32	20	14.13	23.00
14	E	74	4A	14.29	23.10
14	E	116	74	14.45	23.20
14	E	159	9F	14.62	23.30
14	E	203	CB	14.79	23.40
14	E	246	F6	14.96	23.50
15	F	35	23	15.14	23.60
15	F	80	50	15.31	23.70
15	F	125	7D	15.49	23.80
15	F	171	AB	15.67	23.90
15	F	217	D9	15.85	24.00

6. On Chip Image Processing

Data flow of our “On-Chip Image Processing” is written in following figure.
A/D-converted digital signal is input, and processed data is asserted from CSI-2.

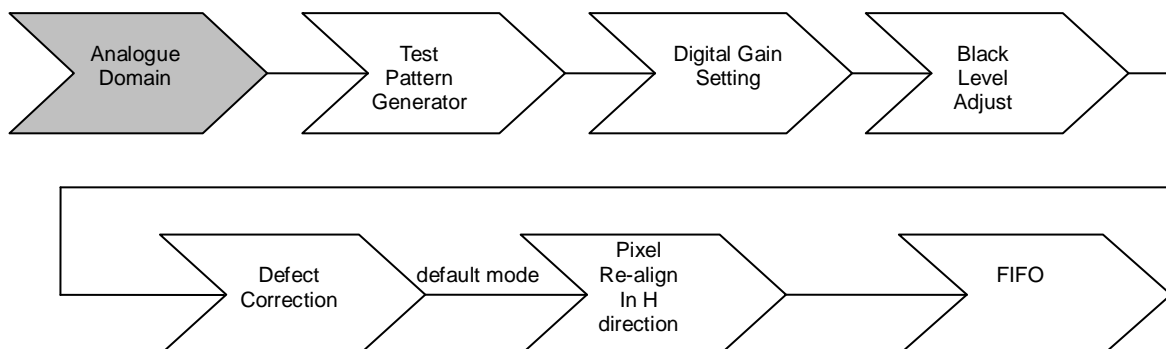

Fig. 32 Data Flow Diagram

6-1 Test Pattern Generator

The IMX219PQH5-C can output test signals using the internal pattern generator.

6-1-1 Test Pattern

The test pattern output function outputs fixed pattern image data from the IMX219PQH5-C. Built-in image patterns can be output by setting the necessary registers.

The registers must be set by communication to output the test pattern. There are no restrictions on the sequence for setting the registers related to test pattern output. The prescribed output is obtained by setting the necessary registers while the sensor is operating.

CONFIDENTIAL

Table 26 Description of Test Pattern Registers

Address	Name	Description
0x0600	test_pattern_mode	0000h – no pattern (default) 0001h – solid color 0002h – 100 % color bars 0003h – fade to grey color bar 0004h – PN9 0005h – 16 split color bar 0006h – 16 split inverted color bar 0007h – column counter 0008h – inverted column counter 0009h – PN31
0x0601		
0x0602	TD_R[9:8]	test_data_red test_data_red
0x0603	TD_R[7:0]	
0x0604	TD_GR[9:8]	test_data_greenR test_data_greenR
0x0605	TD_GR[7:0]	
0x0606	TD_B[9:8]	test_data_blue test_data_blue
0x0607	TD_B[7:0]	
0x0608	TD_GB[9:8]	test_data_greenB test_data_greenB
0x0609	TD_GB[7:0]	
0x060A	H_CUR_WIDTH[15:8]	horizontal_cursor_width horizontal_cursor_width
0x060B	H_CUR_WIDTH[7:0]	
0x060C	H_CUR_POS[15:8]	horizontal_cursor_position horizontal_cursor_position
0x060D	H_CUR_POS[7:0]	
0x060E	V_CUR_WIDTH[15:8]	vertical_cursor_width vertical_cursor_width
0x060F	V_CUR_WIDTH[7:0]	
0x0610	V_CUR_POS[15:8]	vertical_cursor_position vertical_cursor_position
0x0611	V_CUR_POS[7:0]	
0x0612	FRM_RST_OFF	Frame reset control w/ PN9,PN31 0: Frame reset ON (default) 1: Frame reset OFF
0x0620	TP_WINDOW_X_OFFSET[11:8]	test_pattern_window_x_offset
0x0621	TP_WINDOW_X_OFFSET[7:0]	
0x0622	TP_WINDOW_Y_OFFSET[11:8]	test_pattern_window_y_offset
0x0623	TP_WINDOW_Y_OFFSET[7:0]	
0x0624	TP_WINDOW_WIDTH[11:8]	test_pattern_window_width
0x0625	TP_WINDOW_WIDTH[7:0]	
0x0626	TP_WINDOW_HEIGHT[11:8]	test_pattern_window_height
0x0627	TP_WINDOW_HEIGHT[7:0]	

6-1-1-1 Pattern Description

Table 27 Description of Test Patterns

<p>100 % color bar test_pattern_mode = 0002h</p> <hr style="border-top: 1px dashed black;"/>  <p>The image shows a horizontal test pattern. At the top, there is a yellow bar labeled "Embedded data line". Below this bar, there are eight vertical bars of equal width, each a different color: white, yellow, cyan, green, magenta, red, blue, and black.</p>
<p>fade to gray color bar test_pattern_mode = 0003h</p> <hr style="border-top: 1px dashed black;"/>  <p>The image shows a 3x8 grid of test patterns. The top row is a horizontal bar labeled "Embedded data line" with a yellow background. Below it, there are three rows of eight vertical bars each. The colors of the bars in each row are: white, yellow, cyan, green, magenta, red, blue, and black. The bars in the top row are faded to gray, while the bars in the middle and bottom rows are at full saturation.</p>

16 split Color Bar Chart
test_pattern_mode = 0005h

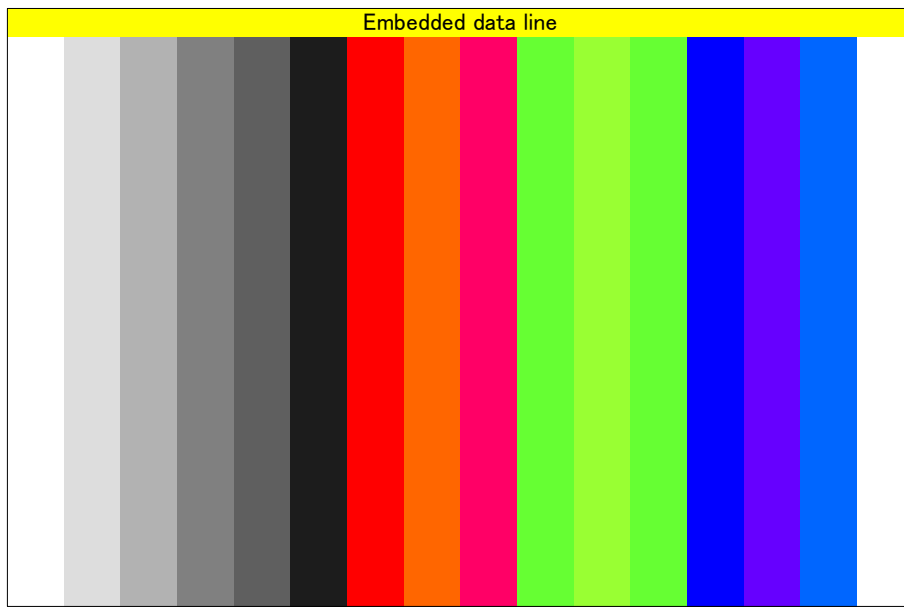

Inversed 16 split Color Bar Chart
test_pattern_mode = 0006h

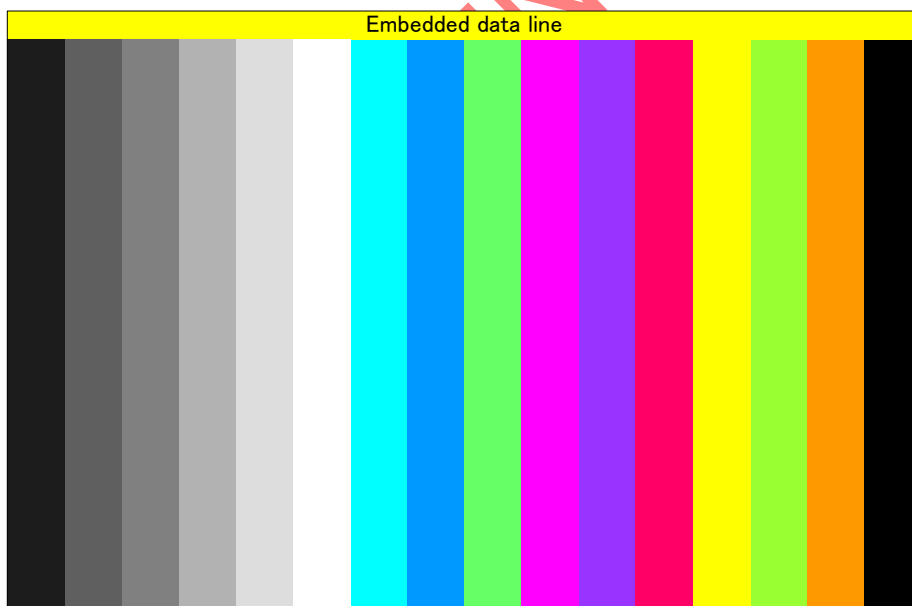

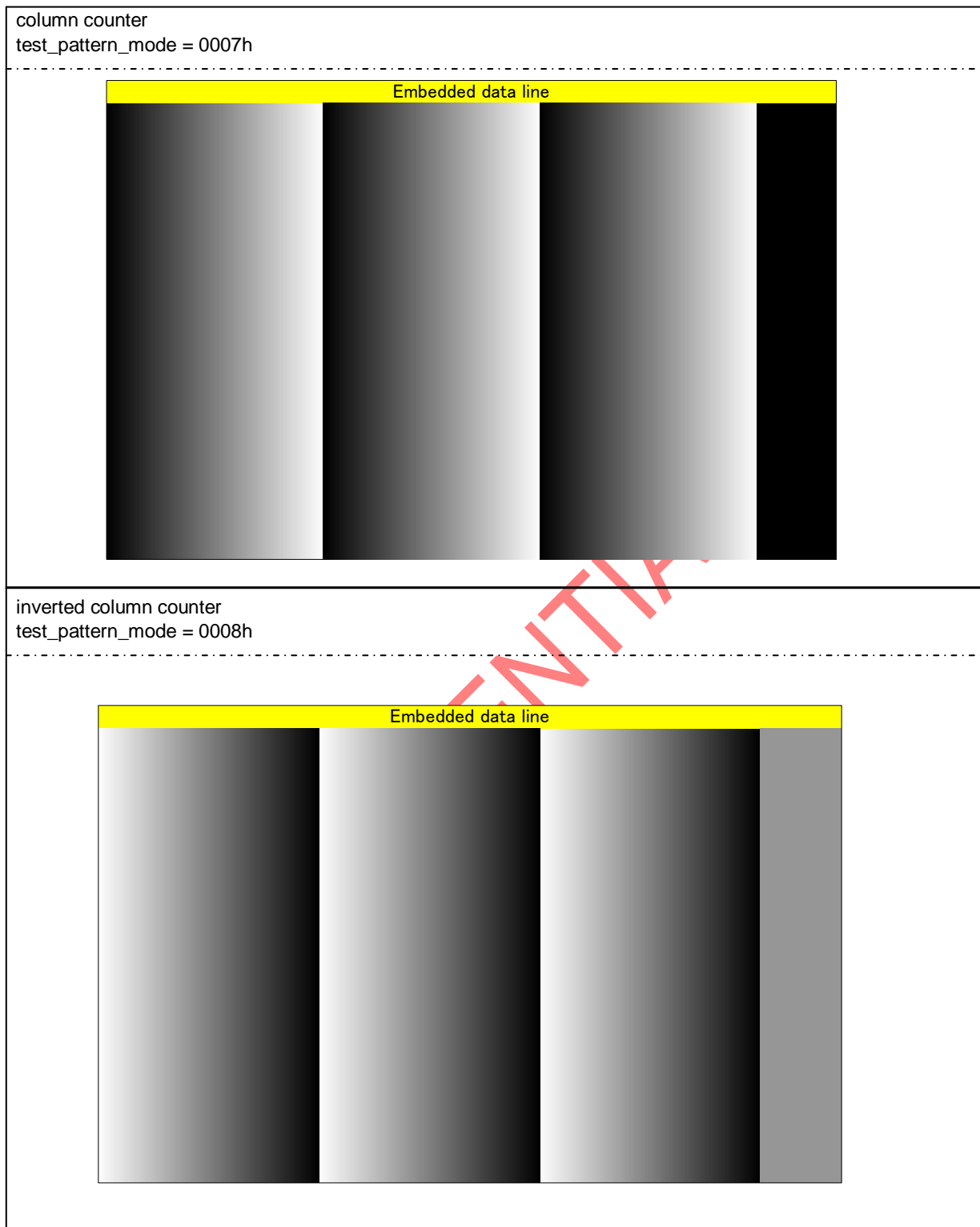

6-2 Digital Gain Setting

See Digital gain settings section.

6-3 Black Level Adjust

The register required to set the Black Level Adjust is as follows.

Table 28 Black Level Adjust Setting Register

Index (HEX)	Bit	Register Name	RW	Comment	Re-Timed	Default (HEX)
D1EA	[1:0]	DT_PEDESTAL[9:8]	RW	Set Black Level		0
D1EB	[7:0]	DT_PEDESTAL[7:0]	RW			40

6-4 Defect Correction

The registers required to set the Defect Correction are as follows.

3 different functions are implemented; (Please refer to “7-5 Defects Address registration” session);

1. Static single defect pixel correction
2. Static same color adjoin pixel correction
3. Static 2x4 defect pixel correction

Defect addresses for mapped_couplet_correct (couplet defect: two adjacent defect pixels of the same color) are stored in NVM , and sensor processes them in itself.

6-5 Pixel Re-alignment H Direction

The registers required to set the Pixel Re-alignment H Direction are as follows.

Table 29 Pixel Re-alignment H Direction Setting Registers

Index	Byte	Register Name	RW	Comment	Re-Time	Default (HEX)	Embd DL
0x0164	[3:0]	X_ADD_STA_A[11:8]	RW	x_addr_start	Frame Bank	0	○
0x0165	[7:0]	X_ADD_STA_A[7:0]	RW			00	○
0x0166	[3:0]	X_ADD_END_A[11:8]	RW	x_addr_end	Frame Bank	C	○
0x0167	[7:0]	X_ADD_END_A[7:0]	RW			CF	○
0x0264	[3:0]	X_ADD_STA_B[11:8]	RW	x_addr_start	Frame Bank	0	○
0x0265	[7:0]	X_ADD_STA_B[7:0]	RW			00	○
0x0266	[3:0]	X_ADD_END_B[11:8]	RW	x_addr_end	Frame Bank	C	○
0x0267	[7:0]	X_ADD_END_B[7:0]	RW			CF	○
0x0174	[0]	BINNING_MODE_H_A	RW	defines binning mode (H-direction). 0: no-binning, 1: x2-binning 2: x4-binning 3: x2-analog (special) binning	Frame Bank	0	○

0x0274	[0]	BINNING_MODE_H_B	RW	defines binning mode (H-direction). 0: no-binning, 1: x2-binning 2: x4-binning 3: x2 analog (special) binning	Frame Bank	0	○
--------	-----	------------------	----	---	------------	---	---

6-6 Pixel Re-alignment V Direction

The registers required to set the Pixel Re-alignment H Direction are as follows.

Table 30 Pixel Re-alignment V Direction Setting Registers

Index	Byte	Register Name	RW	Comment	Re-Time	Default (HEX)	Embd DL
0x168	[3:0]	Y_ADD_STA_A[11:8]	RW	y_addr_start	Frame Bank	00	○
0x169	[7:0]	Y_ADD_STA_A[7:0]	RW		Frame Bank	00	○
0x16A	[3:0]	Y_ADD_END_A[11:8]	RW	y_addr_end	Frame Bank	09	○
0x16B	[7:0]	Y_ADD_END_A[7:0]	RW		Frame Bank	9F	○
0x268	[3:0]	Y_ADD_STA_B[11:8]	RW	y_addr_start	Frame Bank		○
0x269	[7:0]	Y_ADD_STA_B[7:0]	RW		Frame Bank		○
0x26A	[3:0]	Y_ADD_END_B[11:8]	RW	y_addr_end	Frame Bank		○
0x26B	[7:0]	Y_ADD_END_B[7:0]	RW		Frame Bank		○
0x175	[0]	BINNING_MODE_V_A	RW	defines binning mode (V-direction). 0:no-binning 1:x2-binning 2:x4-binning 3:x2 analog (special) binning	Frame Bank		○
0x275	[0]	BINNING_MODE_V_B	RW	defines binning mode (V-direction). 0:no-binning 1:x2-binning 2:x4-binning 3:x2 analog (special) binning	Frame Bank		○

7. NVM Memory Map

7-1 Block Diagram

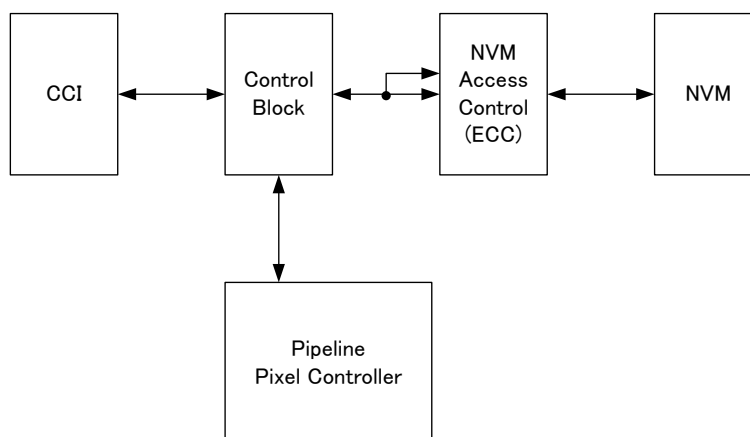

Fig. 33 Block Diagram

NVM is composed of 12 pages (from 0 to 11) and 64 bytes per page. ECC is also applied for every 16 address (bytes), 4 rows in 1 page.

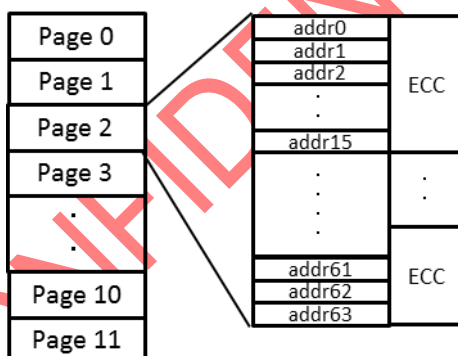

Fig. 34 NVM Map structure

7-2 NVM Functions

NVM block has following functions.

Table 31 Functions via NVM

No	Item	Description
1	Data Interface	User can write/read data via CCI by the unit of page
2	Writing Reg. Value	Writing assigned address and values which are transferred into the assigned registers. (Please refer to Related Registers session "Then when writing;")
3	Writing Defect address	Writing assigned address, whose values are used for defect corrections (Please refer to Defects Address registration session)
4	Reading	Reading NVM data by the unit of page, not ECC region (Please refer to Related Registers session "Then when reading;")
5	ECC Function	Can apply ECC for each 16 bytes (1-row) block. 1-bit per 16 bytes can be corrected.

6	ECC status	Can check while reading/writing that ECC is applied by page. 1. Read data is correct. No ECC is applied. 2. Read data is correct with 1-bit correction of ECC. 3. Read data is incorrect though ECC is applied (means >2 bits per a unit of 16-byte (row) are incorrect).
---	------------	--

7-3 Related Registers

Table 32 Related Registers

Index	Byte	Register Name	RW	Comment	Re-Time	Default (HEX)	Embd DL	Comments
0100	[0]	Mode_sel	RW	Mode select 0: SW- Standby 1: Streaming		0		
3300	[7:0]	SYSOTP_IF_MODE1	RW	OTP mode setting [1:0]: control access cycle to fuse cell 00: INCK cycle 01: INCK/2 cycle 10: INCK/4 cycle 11: INCK/8 cycle [3]: ECC disable switch 0: ECC on, 1: ECC off [5]: write mode; 0: test mode 1: recommended		00		
5E54	[7:0]	OUTF	RW	Monitor Output Enable		C0		
5E59	[7:0]	TESTMNT1	RW	Monitor Output		00		
4053	[7:0]	TEST_FSTRB	RW	Set FStrobe pin to monitor		00		
012A	[7:0]	EXCK_FREQ [15:8]	RW	input_clk_frequency_mhz (default = 7.6[MHz])		07		
012B	[7:0]	EXCK_FREQ [7:0]	RW				99	
3302	[7:0]	SYSOTP_IF_WRCNT[15:8]	RW	OTP write clock setting		00		
3303	[7:0]	SYSOTP_IF_WRCNT[7:0]	RW				00	
3200	[2:0]	OTPIF_CTRL	RW	OTP I/F control register [0] enable [1]R/W [2]error clear		0		
3201	[1:0]	OTPIF_STATUS	RO-D	OTP I/F status; [0] read ready [1] write ready [2] 0: normal 1: Data error exists, and cannot be corrected by ECC. Read data is incorrect.		0		
3202	[2:0]	OTPIF_PAGE_SELECT	RW	otpif_page_select		0		
3204	[7:0]	OTPIF_DT_0	RW	otpif_data_0		00		
(DT_1 to DT_62)								
3243	[7:0]	OTPIF_DT_63	RW	otpif_data_63		00		Trigger to start write sequence

Before writing / reading following steps are required

1. Set Sensor being SW-Standby by 0x0100 = 0h
2. Wait one frame time (See t0 in 8-2 Power off sequence session) when previous status is streaming.
3. Set monitor output to check writing pulse by 0x5E54=00h and 0x5E59=FFh, 4053=0Ah. (option, debug purpose only)
4. Set OTP write clock setting. (target = 25 μ S)
(When INCK = 12.0 MHz, "wrcnt" should be set to 012Ch (target = 25 μ s : 300d) at 0x3302, 0x3303)

Then when writing;

1. Set controller "ECC ON" or ECC OFF" by 0x3300 = "20h" (ECC ON) or "28h" (ECC OFF)
2. Set Write by 0x3200 = "3h."
3. Set page from 0 to 11 by 0x3202.
4. Set 0x3204 to 0x3243 OTPIF_DT_0to 63 = xxh (Data to Write)
Please overwrite all values when you program next page.

OTP controller does NOT clear previous values automatically.

5. Wait write sequence finish (>12.8msec:target [25µs /bit] x 8 bit x 16byte x 4row)

6 Repeat the above (3) – (5) sequence again for twice write process.

Then when reading;

1. Set controller "ECC ON" or "ECC OFF" by 0x3300 = 00h (ECC ON), 08h (ECC OFF) ;

2. Set Read by 0x3200 = "1h."

3. Set page from 0 to 11 by 0x3202.

4. Set 0x3204 to 0x3243 OTPIF_DT_0to 63 = xxh (Data to Write)

CONFIDENTIAL

7-4 NVM Memory Map

Table 33 NVM Memory capacity

Capacity	data Owner
768 byte	Total
688 byte	Integrator
80 byte	Sony

Table 34 NVM Memory Map Example

Page (dec)	Row (dec)	Addr (hex)	Category	Name	Value (hex)	data Owner
0	0-3	000 - 03F				Integrator
1	4-7	040 - 07F				Integrator
2	8-11	080 - 0BF				Integrator
963	12-15	0C0 - 0FF				Integrator
4	16-19	100 - 13F				Integrator
5	20-23	140 - 17F				Integrator
6	24-27	180 - 1BF				Integrator
7	28-31	1C0 - 1FF				Integrator
8	32-35	200 - 23F				Integrator
9	36-39	240 - 27F				Integrator
10	40-41	280 - 29F				Integrator
10	42	2A0	memcfg1	Defines availability of each data [7:1] reserved [0]: defect address available Value 0x00 makes sensor skip copying data from NVM to register.	01	Integrator
10	42	2A1	Defect Correction	defect_num[7:0]		Integrator
10	42	2A2	Defect Correction	{DFCT_SRC_10[1:0]CP_DFCT_DIR_10[1:0] H_DFCT_ADDR_10[11:9]}		Integrator
10	42	2A3	Defect Correction	H_DFCT_ADDR_10[7:0]		Integrator
10	42	2A4	Defect Correction	V_DFCT_ADDR_10[11:4]		Integrator
10	42	2A5	Defect Correction	{V_DFCT_ADDR_10[3:0] DFCT_SRC_11[1:0]CP_DFCT_DIR_11[1:0]}		Integrator
10	42	2A6	Defect Correction	H_DFCT_ADDR_11[11:4]		Integrator
10	42	2A7	Defect Correction	{H_DFCT_ADDR_11[3:0], V_DFCT_ADDR_11[11:8]}		Integrator
10	42	2A8	Defect Correction	V_DFCT_ADDR_11[7:0]		Integrator
10	42	2A9	Defect Correction	{DFCT_SRC_12[1:0]CP_DFCT_DIR_12[1:0] H_DFCT_ADDR_12[11:8]}		Integrator
10	42	2AA	Defect Correction	H_DFCT_ADDR_12[7:0]		Integrator
10	42	2AB	Defect Correction	V_DFCT_ADDR_12[11:4]		Integrator
10	42	2AC	Defect Correction	{V_DFCT_ADDR_12[3:0] DFCT_SRC_13[1:0]CP_DFCT_DIR_13[1:0]}		Integrator
10	42	2AD	Defect Correction	H_DFCT_ADDR_13[11:4]		Integrator
10	42	2AE	Defect Correction	{H_DFCT_ADDR_13[3:0], V_DFCT_ADDR_13[11:8]}		Integrator
10	42	2AF	Defect Correction	H_DFCT_ADDR_13[7:0]		Integrator
10	43	2B0	please don't write	Defect number		Sony
10	43	2B1	please don't write	Defect address (single, 2 adjacent in same color , 2x4 static),10 address		Sony

Page (dec)	Row (dec)	Addr (hex)	Category	Name	Value (hex)	data Owner
11	44	2CE	please don't write	Defect address (single, 2 adjacent in same color , 2x4 static),10 address		Sony
11	44	2CF	please don't write	Defect address (single, 2 adjacent in same color , 2x4 static),10 address		Sony
11	45	2D0	please don't write	Defect address (single, 2 adjacent in same color , 2x4 static),10 address		Sony
11	45	2D1	please don't write	Defect address (single, 2 adjacent in same color , 2x4 static),10 address		Sony
11	45	2D2	please don't write	Defect address (single, 2 adjacent in same color , 2x4 static),10 address		Sony
11	45	2D3	please don't write	Defect address (single, 2 adjacent in same color , 2x4 static),10 address		Sony
11	45	2D4 - 2DF	please don't write	Sony Calibration Area		Sony
11	46	2E0 - 2E5	please don't write	Sony Calibration Area		Sony
11	46	2E6	Fabrication, copy to 0x0002	Sony Calibration Area		Sony
11	46	2E7	Lot ID, copy to 0x0004	Sony Calibration Area		Sony
11	46	2E8	Lot ID, copy to 0x0005	Sony Calibration Area		Sony
11	46	2E9	Lot ID, copy to 0x0006	Sony Calibration Area		Sony
11	46	2EA	Wafer Number, copy to 0x0007	Sony Calibration Area		Sony
11	46	2EB	Chip Number, copy to 0x000D	Sony Calibration Area		Sony
11	46	2EC	Chip Number, copy to 0x000E	Sony Calibration Area		Sony
11	46	2ED	Process revision, 0x000F	Sony Calibration Area		Sony
11	46	2EE - 2EF	please don't write	Sony Calibration Area		Sony
11	47	2F0 - 2FF	please don't write	Sony Calibration Area		Sony

7-5 Defects Address registration

The single defect, the same color adjoining (SCA) defect and 2 x 4 defect are stored into NVM and corrected.

7-5-1 Single defect address

1. Target Address; $(x, y) = (xt, yt)$
 *Output area is Effective Area
 Output size is 3280x2464 (0,0) - (3279,2463)
 $x = \text{image area address} + \text{offset}; \text{offset} = 8d$
 $y = \text{image area address} + \text{offset}; \text{offset} = 48d$ (not include embedded lines)

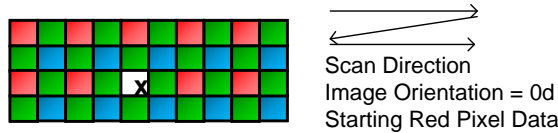

Fig. 35 Single defect

7-5-2 Same Color Adjoining defect address

1. Target Address; $(x, y) = (xt, yt)$
 *Output area is Effective Area
 Output size is 3280x2464 (0,0) - (3279,2463)
 $x = \text{image area address} + \text{offset}; \text{offset} = 8d$
 $y = \text{image area address} + \text{offset}; \text{offset} = 48d$ (not include embedded lines)
2. Directions are also described in the following figure
 0d = defect in right adjoining
 1d = defect in right bottom adjoining
 2d = defect in bottom adjoining
 3d = defect in left bottom adjoining

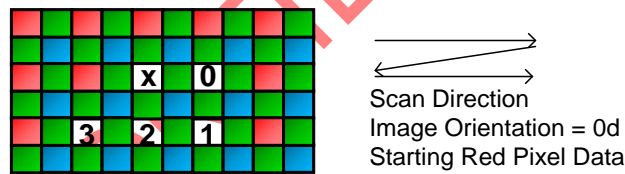

Fig. 36 Same Color Adjoining defect

7-5-3 2x4 defect address

1. Target Address; $(x, y) = (xt, yt)$
 *Output area is Effective Area
 Output size is 3280x2464 (0,0) - (3279,2463)
 $x = \text{image area address} + \text{offset}; \text{offset} = 8d$
 $y = \text{image area address} + \text{offset}; \text{offset} = 48d$ (not include embedded lines)
2. Only upper left pixel address needed in this case, always RED pixels

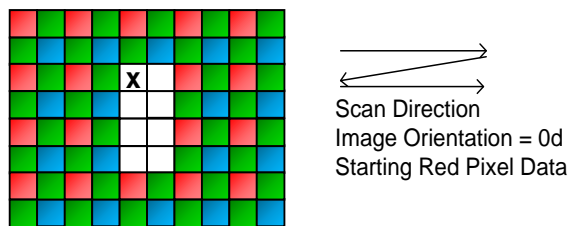

Fig. 37 2x4 defect

7-5-4 Example Setting

Example when defect addr are

1st: (228d, 522d), func: adjoin, dir: 1

2nd: (2846d, 1460d), func: 2x4

3rd: (26d, 20d), single

→ Offset values are (physical address)

1st: (236d, 570d), func: adjoin, SRC = 2, DIR = 1, H_ADR = ECh, V_ADR = 23Ah

2nd: (2854d, 1508d), func: 2x4 SRC = 3, DIR = 0, H_ADR = B26h, V_ADR = 5E4h

3rd: (34d, 68d), func: single SRC = 1, DIR = 0, H_ADR = 22h, V_ADR = 44h

Table 35 Example setting of defect pixel

Addr (hex)	description	Value (hex)
2A0	Defines availability of each data [7:1] reserved [0]: defect address available Value 0x00 makes sensor skip copying data from NVM to register.	01
2A1	defect_num[7:0]	3
2A2	{DFCT_SRC_10[1:0]CP_DFCT_DIR_10[1:0] H_DFCT_ADDR_10[11:9]}	90
2A3	H_DFCT_ADDR_10[7:0]	EC
2A4	V_DFCT_ADDR_10[11:4]	23
2A5	{V_DFCT_ADDR_10[3:0] DFCT_SRC_11[1:0]CP_DFCT_DIR_11[1:0]}	AC
2A6	H_DFCT_ADDR_11[11:4]	B2
2A7	{H_DFCT_ADDR_11[3:0], V_DFCT_ADDR_11[11:8]}	65
2A8	V_DFCT_ADDR_11[7:0]	E4
2A9	{DFCT_SRC_12[1:0]CP_DFCT_DIR_12[1:0] H_DFCT_ADDR_12[11:8]}	40
2AA	H_DFCT_ADDR_12[7:0]	22
2AB	V_DFCT_ADDR_12[11:4]	04
2AC	{V_DFCT_ADDR_12[3:0] DFCT_SRC_13[1:0]CP_DFCT_DIR_13[1:0]}	40
2AD	H_DFCT_ADDR_13[11:4]	00
2AE	{H_DFCT_ADDR_13[3:0], V_DFCT_ADDR_13[11:8]}	00
2AF	H_DFCT_ADDR_13[7:0]	00

8. How to operate IMX219PQH5-C

8-1 Power on sequence

Power on sequence of IMX219PQH5-C is below figure.

Startup Sequence in 2-wire Serial Communication Mode

Perform power-on according to the following sequence.

The XCLR pin must be released (Low → High) after all the power supplies (VANA,VDIG,VDDL) are completed.

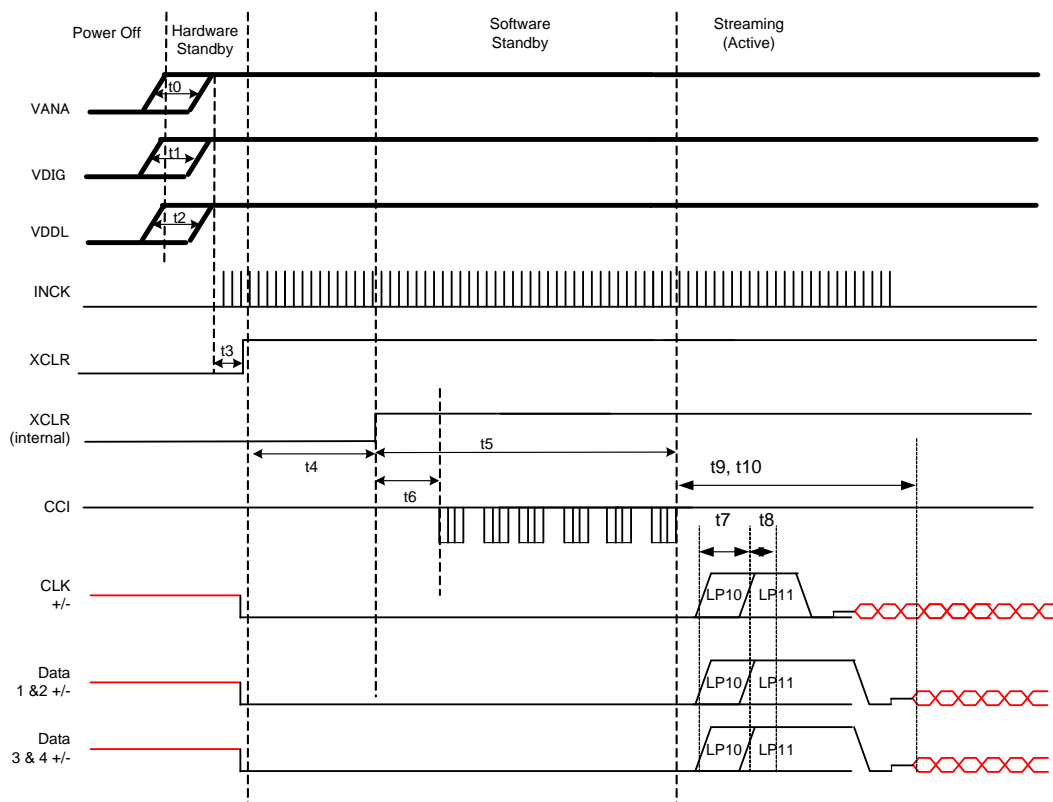

Fig. 38 Power-on Sequence in 2-wire Serial Communication Mode

Table 36 Operation Specifications 2-wire Serial Communication Mode

Constraint	Label	Min.	Max.	Units	Comment
Sequence free of VDDs rising	t0, t1, t2	VANA, VDIG, VDDL may rise in any order.		ns	
XCLR rising	t3	0.5	—	μs	
Internal XCLR is Low to High after VDDs & XCLR supplied	t4		200	μs	
releasing software standby after XCLR Low to High	t5	6	—	ms	charge up VRL
Initializing time of silicon	t6	—	32000	clocks	clock is INCK Case of INCK = 6[MHz], 5.3[msec]
D-PHY power-up	t7	1	1.1	ms	
D-PHY init	t8	100	110	μs	
After releasing software standby to data streaming time	t9	1.2 ms + exposure time	—		
Quick launch up time	t10	—	1	frame	stable time until optimal image quality

Start streaming sequence with 2-wire serial communication

IMX219PQH5-C requires the command sequence below to output image data.

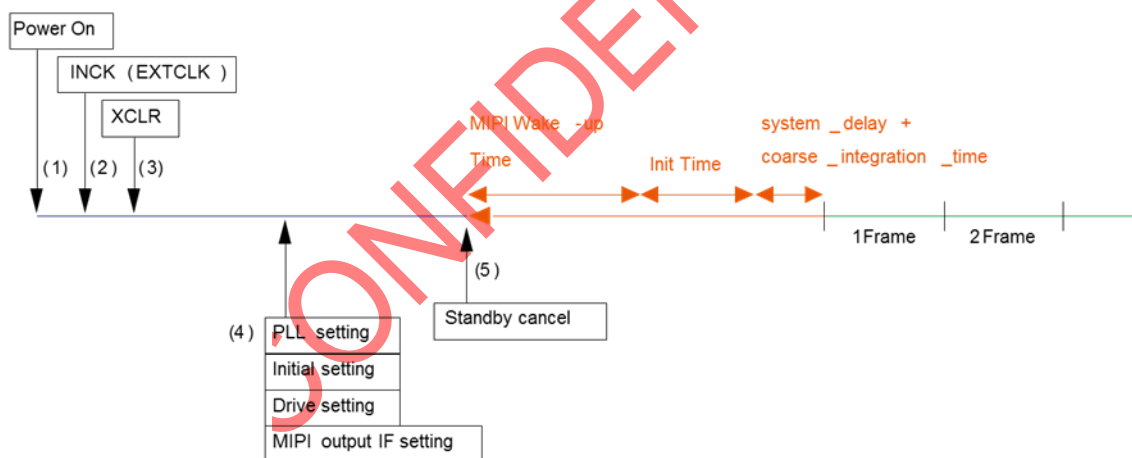

Fig. 39 Start streaming sequence with 2-wire serial communication (external reset)

Table 37 Initialization sequence with XCLR

(1) to (3)	Refer power up sequence timing diagram
(4)	Set PLL parameters
	Basic setting (operation-critical setting)
	Set Readout mode (start/end position, size, mode, integration time, and gain)
	Set MIPI interface parameters
(5)	Start streaming with 0x0100 (mode_select = 1)
	After "MIPI Wake Up Time" + "Init Time", 1 st frame starts and images come out

8-2 Power off sequence

Perform the power-off in the sequence shown below.

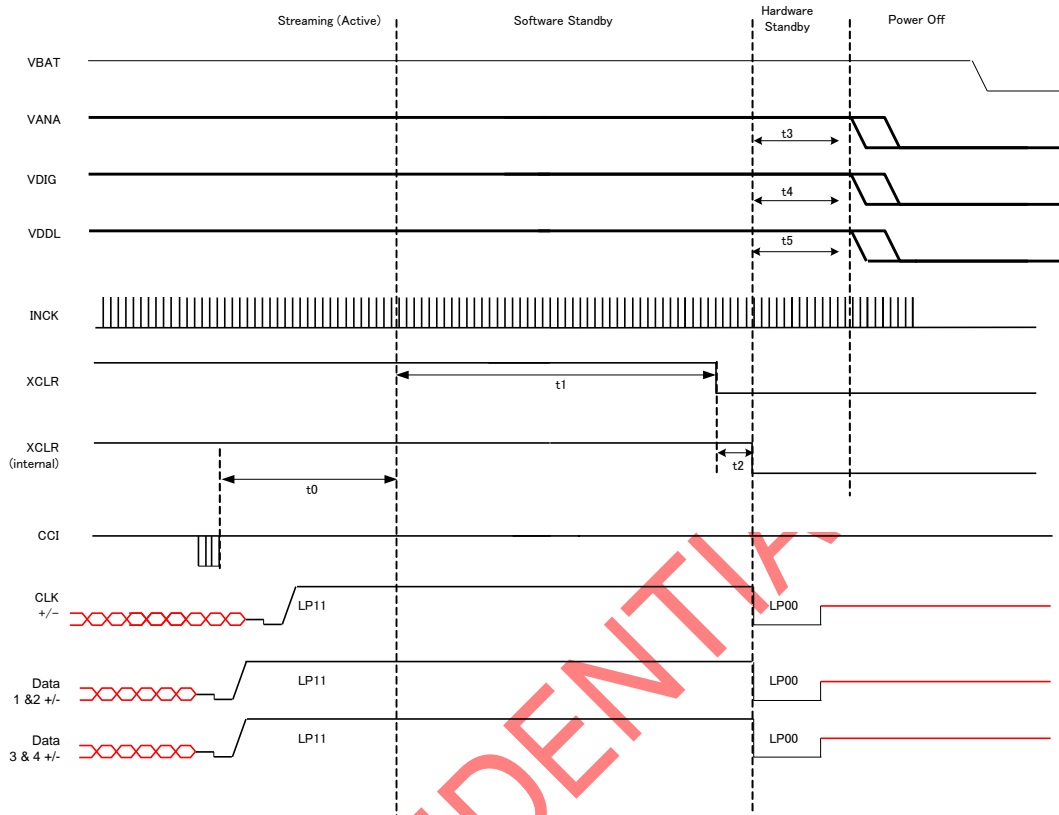

Fig. 40 Power-off Sequence in 2-wire Serial Communication

Table 38 Operation Specifications in 2-wire Serial Communication

Constraint	Label	Min.	Max.	Units	Comment
Communication end – Software standby	t0		One frame time (*1)	s	Until frame output
Software standby - XCLR H → L	t1	0		ns	
Falling time of internal XCLR after XCLR H → L	t2		10	μs	
VANA falling - VDIG falling - VDDL falling	t3,t4,t5		VANA, VDIG and VDDL may fall in any order.	ns	

(*1) One frame time = 1/(Frame_Rate[frame/s])

Can set fast standby mode when fast standby register (0x0106)] set to enable (0x01).

Sequence for fast standby mode;

- (1) 0x0106 set to 0x01 (fast standby mode is enable)
- (2) 0x0100 set to 0x00 (SW standby)
- (3) Can change to SW standby after read out of current line.

To in power-off sequence varies depending on the CCI communication end timing as shown below.

1. When the CCI communication is performed with Software Standby between SOF and EOF, all communicated frame data is output and the status is converted to Software Standby.

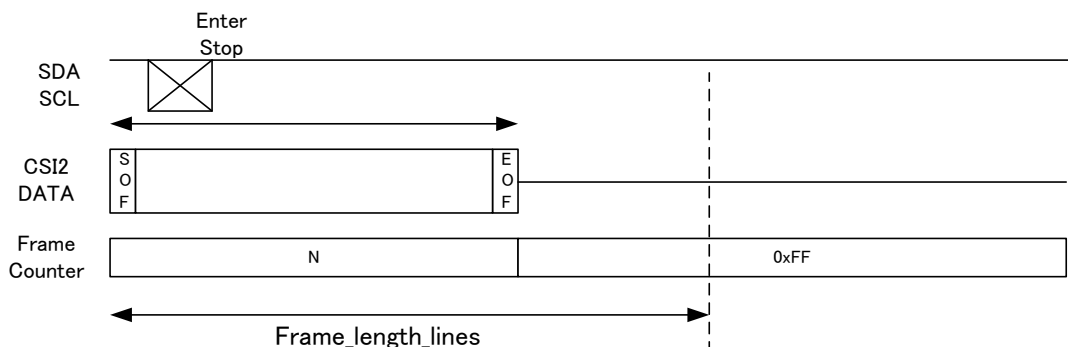

Fig. 41 Software Standby Operation Pattern 1

2. When the CCI communication is performed with Software Standby during FrameBlanking, the status is converted to Software Standby immediately after communication.

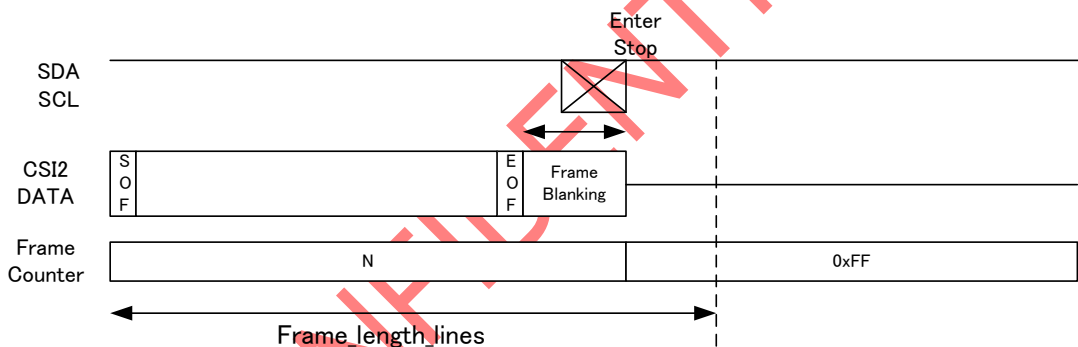

Fig. 42 Software Standby Operation Pattern 2

9. Other Functions

9-1 Clock System

9-1-1 Clock Structure

The IMX219PQH5-C clock system has the following structure.

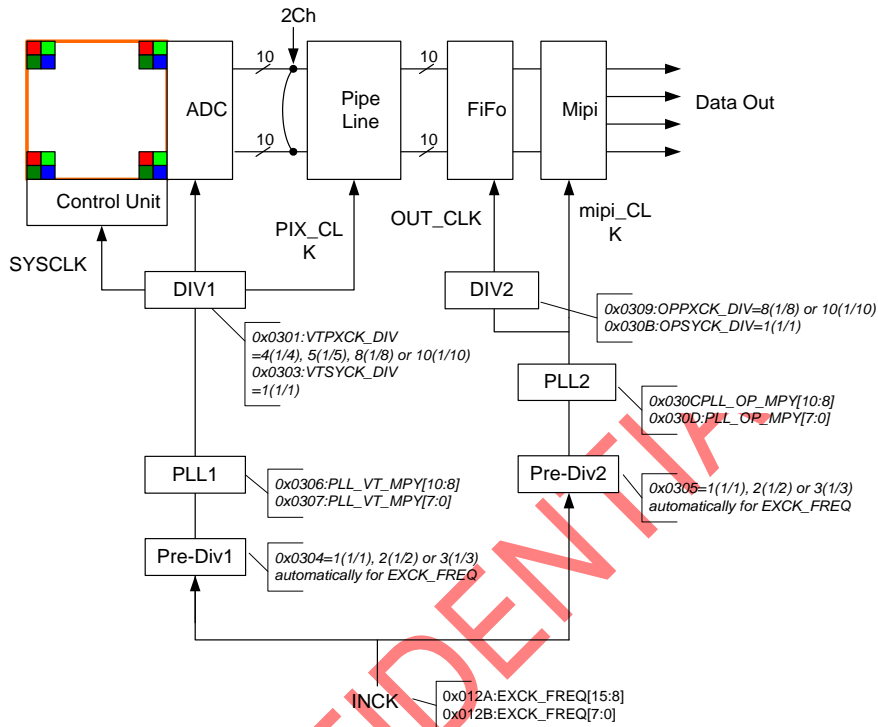

Fig. 43 Clock System Block Diagram

The IMX219PQH5-C is comprised of 2 ch Pipe-Line, and 2 PLL for both pixel read domain and Output data domain. See following section (Clock Setting Example) for detail.

Relationships between 2 domains are the followings;

- 1 If, Pix Rate of PLL1 domain < Data Rate of PLL2 domain, data is always correctly output from the sensor
- 2 If Pix Rate of PLL1 domain > Data rate of PLL2 domain, Else If de-rating (binning and sub-sampling without resize), FiFo can handle.

9-1-2 EXCK_FREQ setting depend on INCK frequency

The IMX219PQH5-C has the function that automatically set Pre-Div1 and Pre-Div2 by setting the register by setting the register of EXCK_FREQ, case of changing INCK frequency.

Table 39 EXCK_FREQ setting table

INCK (Input Pin)	EXCK_FREQ (0x012A/0x012B)	PREPLLCK_VT_DIV (0x0304)	PREPLLCK_OP_DIV (0x0305)	Remark
6 to 12[MHz]	6d to 12d (06h to 0Ch)	01h (auto set)	01h (auto set)	
12 to 24[MHz]	12d to 24d (0Ch to 18h)	02h (auto set)	02h (auto set)	
24 to 27[MHz]	24d to 27d (18h to 1Bh)	03h (auto set)	03h (auto set)	

9-2 Clock Setting Example

Interface	CSI-2	CSI-2	CSI-2
ADC bit width	10	10	10
Data Mode	Raw10	Raw10	Raw10
FPS	30 frame/s	180 frame/s	21 frame/s (*1)
Lanes	4	4	2
Bin	Full-Pel	2 (V) X2 (H) analog (special) binning	Full-Pel
Sub			
Output Size (H, V)	3280 x 2464	1408 x 792	3280 x 2464
pll1_vt_freq	702 MHz	702 MHz	456 MHz
EXCK_FREQ	12	12	12
VTSYCK_DIV	1	1	1
vt_pix_clk_div	5	5	10
Pix Rate	280.8M pix	280.8M pix	182.4M pix
Actual freq (VTCK)	140.4 MHz	140.4 MHz	91.2 MHz
pll2_op_freq	726 MHz	726 MHz	912 MHz
op_sys_clk_div	1	1	1
op_pix_clk_div	10	10	10
de-rating	1	1	1
Output Lanes	4	4	2
Actual freq (OPCK)	72.6 MHz	72.6 MHz	91.2 MHz
Actual MIPI-freq (byte)	90.75 MHz	90.75 MHz	114 MHz
Speed/Lane (Ch)	726 Mbps	726 Mbps	912 Mbps
Total Output Rate	2.904 Gbps	2.904 Gbps	1.824 Gbps

*1 Max. frame rate is 21 frame/s

9-3 Temperature Sensor

Registers to be related about temperature sensor are the followings.

Table 40 Temperature setting registers

Index	Byte	Register Name	RW	Comment	Re-Time	Default (HEX)	Embd DL	Comments
0x0140	[7]	TEMPERATURE_EN	RW	start register to measure sensor temperature		0		
	[6:0]	TEMPERATURE_VAL	RO-D	result of measurement of sensor temperature		00		

The temperature sensor measures the junction temperature of the sensor silicon. The target range is -10 to 95 degrees in C, with +/- 5 degree in C deviation. The sensor is operated immediately after streaming mode, and the value will be stored in the register.

The following table shows the relationship between temperature and stored value.

Temperature[°C]	temperature_val[dec]	temperature_val[hex]
-10	0	0
-5	6	6
0	12	C
5	18	12
10	24	18
15	30	1E
20	36	24
25	43	2B
30	49	31
35	55	37
40	61	3D
45	67	43
50	73	49
55	79	4F
60	85	55
65	91	5B
70	97	61
75	104	68
80	110	6E
85	116	74
90	122	7A
95	128	80

10. Electrical Characteristics

10-1 Absolute Maximum Ratings

Table 41 Absolute Maximum Ratings

Item	Symbol	Min.	Typ.	Max.	Unit	Remarks
Supply voltage (analogue)	V _{ANA}	-0.3		3.3	V	
Supply voltage (Core)	V _{DDL}	-0.3		2.0	V	
Supply voltage (IF)	V _{DIG}	-0.3		3.3	V	
Input voltage	V _I	-0.3		3.3	V	
Output voltage	V _O	-0.3		3.3	V	
Operating temperature (function)	T _{opr}	-20		60	°C	Junction temperature
Storage temperature	T _{stg}	-30		80	°C	Junction temperature
Performance guarantee temperature	T _{spec}	-20		60	°C	Junction temperature

10-2 Recommended Operating Conditions

Table 42 Recommended Operating Conditions

Item	Symbol	Min.	Typ.	Max.	Unit	Remarks
Supply voltage (analogue)	V _{ANA}	2.6	2.8	3.0	V	
Supply voltage (Core)	V _{DDL}	1.08	1.2	1.3	V	
Supply voltage (IF)	V _{DIG}	1.62	1.8	1.98	V	

10-3 Electrical Characteristics

Table 43 DC Characteristics

Item	Pins	Symbol	Min.	Typ.	Max.	Unit	Comment
Supply voltage	VDDHFIL1,2	V_{ANA}	2.6	2.8	3.0	V	
	VDDHCM1,2						
	VDDHAN						
	VDDHPL						
	VDDHSN1,2						
	VDDMCO	V_{DIG}	1.62	1.8	1.98	V	
	VDDLSC1-8	V_{DDL}	1.08	1.20	1.30	V	
	VDDLNC1,2						
VDDLIO1,2							
Digital input/output voltage	SCL, SDA, GPO	VIL	-0.5		$0.3V_{DIG}$	V	
		VIH	$0.7V_{DIG}$		$V_{DIG} + 0.5$	V	
		VOL			$0.25V_{DIG}$	V	
		VOH	$0.75V_{DIG}$			V	
Digital output voltage	FSTROBE	VOL			0.45	V	
		VOH	$V_{DIG} - 0.45$				
Digital input voltage	XCLR, INCK	VIL	-0.3		$0.35V_{DIG}$	V	
		VIH	$0.65V_{DIG}$		$V_{DIG} + 0.3$		

CONFIDENTIAL

10-4 AC Characteristics

10-4-1 Master Clock Waveform Diagram

10-4-1-1 INCK Square Waveform Input Specifications

Input specifications are shown below when square-wave inputs directly into the external pin INCK.

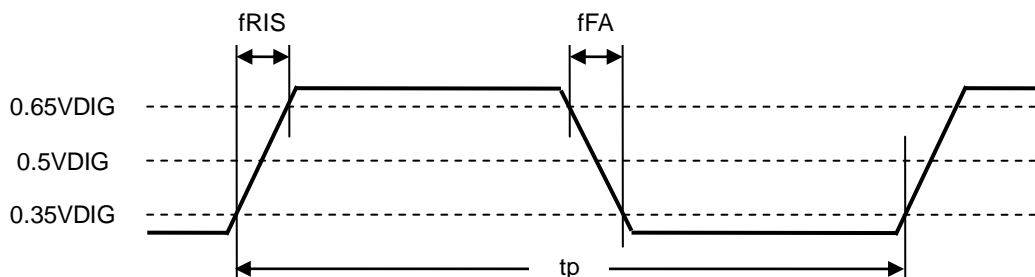

Fig. 44 Master Clock Square Waveform Diagram

Table 44 Master Clock Square Waveform Input Characteristics

Item	Symbol	Min.	Typ.	Max.	Unit	Comment
Frequency	fSCK	6	18	27	MHz	
jitter (period, peak-to-peak)	Tjitter			600	ps	
Rise Time	fRISE	1		10	ns	
Fall Time	fFALL	1		10	ns	
Duty Cycle	fDUTY	40		60	%	
Input Leakage	fILEAK	-10		10	μA	

10-5 Electrical Characteristics

Table 45 Electrical Characteristics

(VANA = 3.0 V, VDDL = 1.3 V, VDIG = 1.98 V, Tj = 60 °C)

Item	Symbol	Min.	Typ.	Max.	Unit	Comment
Current consumption (Full, 30 frame/s)	IVAVA_strm		33	38	mA	VTmax is max speed read out from pixel array CSI2 4 lanes, VANA current
	IVDDL_strm		100	160	mA	VTmax is max speed read out from pixel array CSI2 4 lanes, VDDL current Defect Correction, L.S.C. function off
HW-Standby current	ISTB_ana			50	μA	XCLR = Lo, VANA current
	ISTB_dig			10	μA	XCLR = Lo, VDIG current
	ISTB_iddl			50	μA	XCLR = Lo, VDDL current

Note) Measurement conditions

11. Spectral Sensitivity Characteristic

(Neither lens characteristics nor light source characteristics is included.)

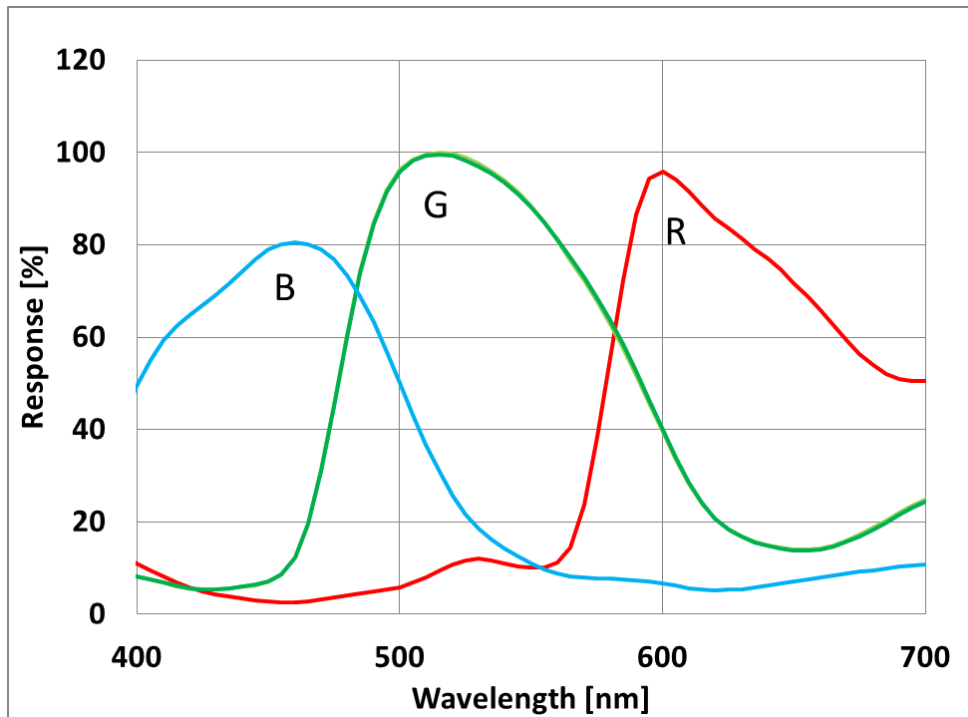

Fig. 45 Spectral sensitivity characteristics

CONFIDENTIAL

12. Image Sensor Characteristics

12-1 Image Sensor Characteristics

Table 46 Image Sensor Characteristics

(30 frame/s, $V_{ANA} = 2.8\text{ V}$, $V_{DIG} = 1.2\text{ V}$, $V_{IF} = 1.8\text{ V}$, $T_j = 60\text{ }^\circ\text{C}$)

Item	Symbol	Min.	Typ.	Max.	Unit	Range	Measurement method	Remarks
Sensitivity	S	205			LSB	Center	1	1/120 s storage
Sensitivity ratio	RG	0.45	0.51	0.57		Center	2	
	BG	0.40	0.46	0.52				
Saturation signal	Vsat	1023			LSB	Zone1	3	
Video signal shading	SH			70	%	Zone2D	4	Design assurance
Dark signal	Vdt			0.5	LSB	Zone2D	5	When operation at 15 frame/s

LSB is the abbreviation of Least Significant Bit. 10 bits = 1023 digital is the maximum output code for the output unit. The base gain in which the saturation signal output matches with 1023 LSB is 0[dB] when the OB level is 64 LSB (standard recommended value). The data described at this image sensor characteristics are the measurement standard without base gain setting, and indicates the results evaluated with OB as a reference.

12-2 Zone Definition used for specifying image sensor characteristics

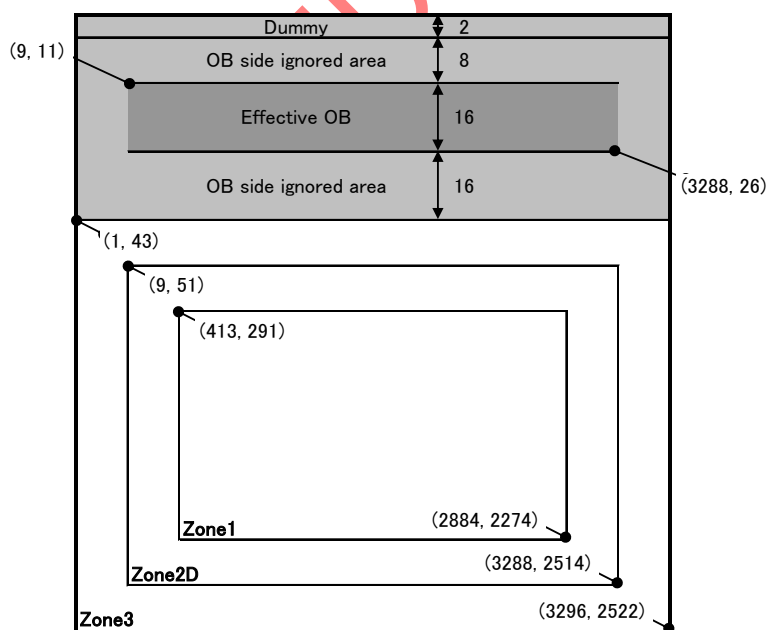

Fig. 46 Zone Definition Diagram

13. Measurement Method for Image Sensor Characteristics

13-1 Measurement conditions

The device operation conditions are at the typical values of the bias and clock voltage.

Table 47 Measurement Conditions

Supply voltage	Analog 2.8 V, digital 1.2 V, IF 1.8 V
Clock	INCK (EXTCLK) 18 MHz

In the following measurements, spot pixels are excluded and, unless otherwise specified, the optical black (OB) level is used as the reference for the signal output, which is taken as the value of the Gr, Gb, R and B digital signal outputs of the measurement system.

As an example of 1 LSB, the typical value is 1 LSB ≈ 0.357 mV in all-pixel output 10-bit operation mode.

13-2 Color Coding of This Image Sensor and Readout

The primary color filters of this image sensor are arranged in the layout shown in the figure below. Gr and Gb denote the G signals on the same line as the R signal and the B signal, respectively. The R signal and Gr signal lines and the Gb signal and B signal lines are output successively.

All pixel signals are output successively in a 1/15 s period.

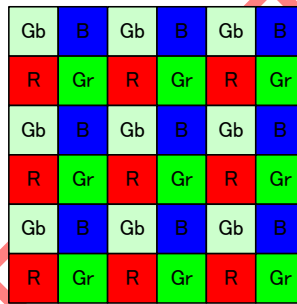

Fig. 47 Color coding alignment

13-3 Definition of Standard Imaging Conditions

Standard imaging condition I

Use a pattern box (luminance: 706 cd/m², color temperature of 3200 K halogen source) as a subject. (Pattern for evaluation is not applicable.) Use a testing standard lens with CM500S (t = 1.0 mm) as an IR cut filter and image at F2.8. The luminous intensity to the sensor receiving surface at this point is defined as the standard sensitivity testing luminous intensity.

Standard imaging condition II

A testing lens with CM500S (t = 1.0 mm) is used as an IR cut filter for light source with 3200 K color temperature. The luminous intensity to the sensor receiving surface is adjusted to the luminous intensity level shown in each measurement item by the light source output, lens aperture or storage time control by the electronic shutter.

Standard imaging condition III

A recommended testing lens with CM500S (t = 1.0 mm) is used as an IR cut filter for light source with 3200 K color temperature. The luminous intensity to the sensor receiving surface is adjusted to the luminous intensity level shown in each measurement item by the light source output or storage time control by the electronic shutter.

13-4 Measurement method

Sensitivity

Set the measurement condition to the standard imaging condition I. After setting the luminous intensity of 10 times that of the standard imaging condition and the electronic shutter mode with a shutter speed of 1/150 s, measure the Gr and Gb signal outputs (VGr, VGb) at the center of imaging area, and substitute the values into the following formula.

$$S = \{((VGr + VGb)/2) \times (1/10) \times (150/120)\} \text{ [LSB]}$$

Sensitivity ratio

Set the measurement condition to the standard imaging condition II. After adjusting so that the average value of the Gr and Gb signal output is 333 [LSB], measure the R signal output (VR [LSB]), the Gr and Gb signal outputs (VGr, VGb [LSB]) and the B signal output (VB [LSB]) at the imaging area Center in frame readout mode, and substitute the values into the following formulas.

$$VG = (VGr + VGb)/2$$

$$RG = VR/VG$$

$$RB = VB/VG$$

Saturation signal

Set the measurement condition to the standard imaging condition II. After adjusting the luminous intensity to 20 times the intensity with the average value of the Gr, Gb signal outputs, 333 [LSB], measure the average value of the Gr, Gb, R and B signal outputs.

Video signal shading

Set the measurement condition to the standard imaging condition III. With the lens diaphragm at F2.8, adjust the luminous intensity so that the average value of the Gr and Gb signal outputs is 333 [LSB]. Then measure the maximum value (Gmax [LSB]) and minimum value (Gmin [LSB]) of the Gr and Gb signal outputs, and substitute the values into the following formula.

$$SH = ((Gmax - Gmin)/Gmax) \times 100 \text{ [%]}$$

Dark signal

Measure the output difference between 1/15 [s] signal output (Va) and 1/15000 or less [s] signal output (Vb) at the device ambient temperature of 60 °C and the device in the light-obstructed state, and calculate the signal output at 1/15 [s] storage by them using the following approximate formula. Then, this is Vdt [LSB].

$$Vdt = (Va - Vb) \times (1/15) / ((1/15) - (1/15000)) \approx (Va - Vb) \text{ [LSB]}$$

14. Spot Pixel Specification

Table 48 Spot Pixel Specifications

(15 frame/s, $V_{ANA} = 2.8\text{ V}$, $V_{DIG} = 1.2\text{ V}$, $V_{IF} = 1.8\text{ V}$, $T_j = 60\text{ }^\circ\text{C}$)

Type of distortion	Level Note 1)	Maximum distorted pixels in each zone				Measurement method	Remarks
		Zone2D	Zone3	Ineffective OB	Effective OB		
Black or white pixels at high light	$30\% \leq D$	40	No evaluation criteria applied		2		
White pixels in the dark	$28\text{ (LSB)} \leq D$	600	No evaluation criteria applied		2	1/30 s storage Note 2)	

- Note)
1. D...Spot pixel level.
 2. Continuous same color pixels in the horizontal or vertical direction are NG.
 3. The above chart (hereinafter referred to as the "Spot Pixel Specifications") is the standard only for sorting image sensor products in this specification book (hereinafter referred to as the "PRODUCTS") before shipment from a manufacturing factory. Sony Corporation and its distributors (collectively hereinafter referred to as the "Seller") disclaim and will not assume any liability even if actual number of distorted pixels of the PRODUCTS delivered to you exceeds the maximum number set forth in the White and Black Pixel Specifications. You are solely liable for any claim, damage or liability arising from or in connection with such distorted pixels. If the Seller separately has its own product warranty program for the PRODUCTS (the "Program"), the conditions in this specification book shall prevail over the Program and the Seller shall not assume any liability under the Program to the extent there is contradiction.

CONFIDENTIAL

15. Notice on White Pixels Specifications

After shipment inspection of CMOS image sensors, pixels of CMOS image sensors may be distorted and then distorted pixels may cause white point effects in dark signals in picture images. (Such white point effects shall be hereinafter referred to as "White Pixels.") Cosmic radiation is one of the causes of White Pixels. Unfortunately, it is not possible with current scientific technology for CMOS image sensors to prevent such distorted pixels. It is recommended that when you use CMOS image sensors, you should consider taking measures against White Pixels, such as adoption of automatic compensation systems for White Pixels and establishment of quality assurance standards.

White Pixels may be also caused by alpha radiation, which will be emitted in a process of decay of radioactive isotopes which inevitably exist in the air in minute amounts and may exist in materials or parts of CMOS image sensor devices (e.g. packaging materials, seal glass, wiring materials and IC chips). It is recommended that you should use materials or parts which do not include radioactive isotopes, which are sources of alpha radiation, and consider taking measures, such as adoption of vacuum packaging technologies in order to ensure that the PRODUCTS are not exposed to the air. As the density of radioactive isotopes in the air of the underground space may become thicker than that on the ground, it is highly recommended to ensure the PRODUCTS are not exposed to the air in using or storing the PRODUCTS at the underground space.

[For Your Reference] The Annual number of White Pixels Occurrence Caused by Cosmic Radiation

The data in the below chart shows the estimated annual number of White Pixels occurrence caused by cosmic radiation in a single-story building in Tokyo at an altitude of 0 meters. The data shows estimated number of White Pixels based on records of past field tests calculated taking structures and electrical properties of each device into account. However, the data in the chart is for your reference purpose only, and shall not be construed as part of any CMOS image sensor product specifications which the Seller warrants.

Example of Annual Number of Occurrence

White Pixel Level (in case of integration time = 1/30 s) (T _j = 60 °C)	Annual number of occurrence
5.6 mV or higher	0.8 pcs
10.0 mV or higher	0.5 pcs
24.0 mV or higher	0.3 pcs
50.0 mV or higher	0.2 pcs
72.0 mV or higher	0.1 pcs

Note 1) The above data indicates the number of White Pixels occurrence when a CMOS image sensor is left for a year.

Note 2) The annual number of White Pixels occurrence fluctuates depending on the CMOS image sensor storage environment (such as altitude, geomagnetic latitude and building structure), time (solar activity effects) and so on. Moreover, there may be statistic errors. Please take notice and understand that this is an example of test data with experiments that have being conducted over a specific time period and in a specific environment.

Note 3) This data does not guarantee the upper limits of the annual number of White Pixels occurrence.

Note 4) As this data does not take occurrence of White Pixels caused by alpha radiation into account, White Pixels are likely to occur at higher value than the rate set forth in such data.

For Your Reference:

The annual number of White Pixels occurrence caused by cosmic radiation at an altitude of 3,000 meters will be from 5 to 10 times higher than that at an altitude of 0 meters because of the density of the cosmic rays. In addition, in high latitude geographical areas such as London and New York, the density of cosmic rays increases due to a difference in the geomagnetic density, so the annual number of White Pixels occurrence caused by cosmic radiation in such areas approximately doubles when compared with that in Tokyo.

15-1 Measurement Method for Spot Pixels

Measure under the standard imaging condition II.

15-2 Spot Pixel Pattern Specifications

Black or white pixels at high light

After adjusting the average value of the Gr/Gb signal output to 333 [LSB], measure the local dip point (black pixel at high light, VXB) and peak point (white pixel at high light, VXK) in the Gr/Gb signal output Vx (x = Gr/Gb), and substitute the values into the following formula.

$$D_k (\text{White pixel level}) = (\overline{V_{XK}} / \overline{V_x}) \times 100 [\%]$$

$$D_b (\text{Black pixel level}) = (\overline{V_{XB}} / \overline{V_x}) \times 100 [\%]$$

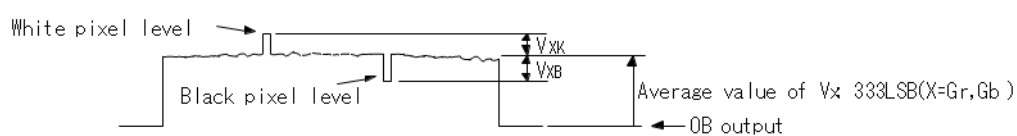

Fig. 48 Measurement Method for Spot Pixels

White pixels in the dark

Set the device to a dark setting and measure the local peak point of the signal output waveform using the average value of the dark signal output as a reference.

16. Chief Ray Angle Characteristics

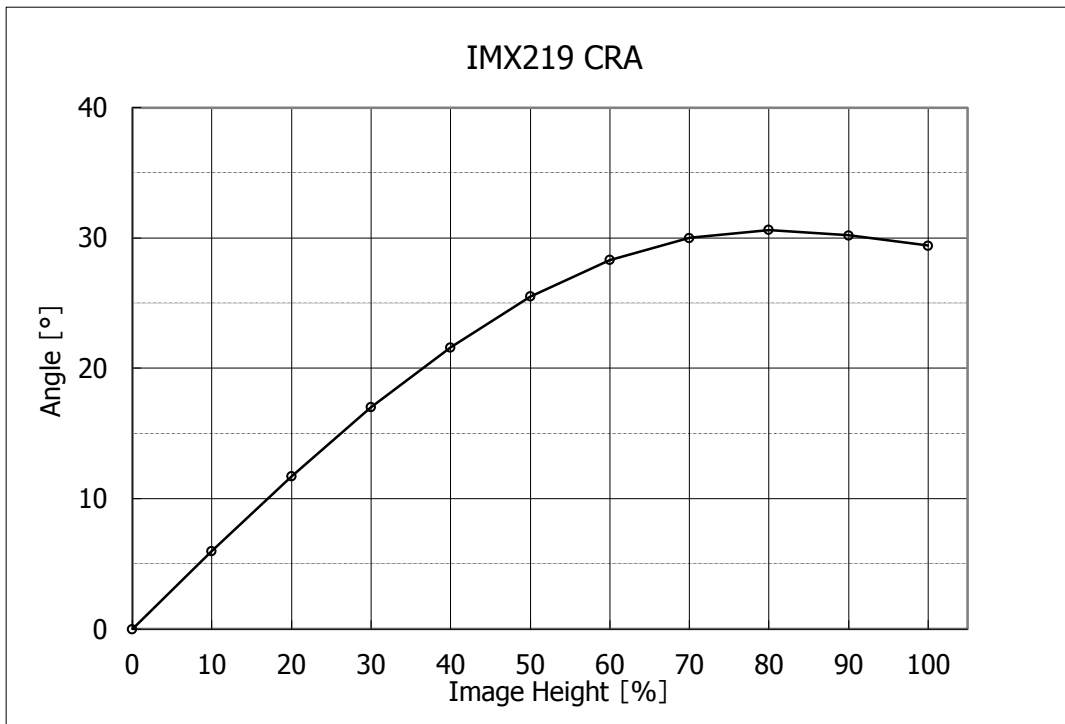

Fig. 49 Chief Ray Angle Characteristics

CONFIDENTIAL

18. Notes On Handling

1. Static charge prevention

Image sensors are easily damaged by static discharge. Before handling be sure to take the following protective measures.

- (1) Either handle bare handed or use non-chargeable gloves, clothes or material.
Also use conductive shoes.
- (2) Use a wrist strap when handling directly.
- (3) Install grounded conductive mats on the floor and working table to prevent the generation of static electricity.
- (4) Ionized air is recommended for discharge when handling image sensors.
- (5) For the shipment of mounted boards, use boxes treated for the prevention of static charges.

2. Protection from dust and dirt

- (1) Perform all work in a clean environment.
- (2) Do not touch the chip surface with hand and make any object contact with it.
- (3) Keep in a dedicated case to protect from dust and dirt. To prevent dew condensation, preheat or precool when moving to a room with great temperature differences.

3. Others

- (1) Do not expose to strong light (sun rays) for long periods, as the color filters of color devices will be discolored.
- (2) Exposure to high temperature or humidity will affect the characteristics. Accordingly avoid storage or use in such conditions.
- (3) This product is precision optical parts, so care should be taken not to apply excessive mechanical shocks or force.
- (4) Reliability assurance of this product should be ignored because it is a bare chip.
- (5) Note that imaging characteristics of the sensor may be affected when approaching strong electromagnetic wave or magnetic field during operation.
- (6) Note that X-ray inspection may damage characteristics of the sensor.
- (7) Note that the sensor may be damaged when using ultraviolet ray and infrared laser for mounting it.
- (8) Note that image may be affected by the light leaked to optical black when using an infrared cut filter that has transparency in near infrared ray area during shooting subjects with high luminance.